

**INTERPHONE**  
STAY IN TOUCH

 **Bluetooth™**



 **cellularline**

**LINK**

**USER GUIDE**

<b>Chap. 1 - Introduction</b>	<b>3</b>
1.1 Presentation	3
1.2 Warnings	3
1.3 Main specifications	3
1.4 Package contents	3
<b>Chap. 2 - Getting started</b>	<b>4</b>
2.1 Installation instructions	4
2.2 Main commands	4
2.3 - Battery charging	5
2.4 LED indication	5
2.5 Initial ignition (only dual unit version)	5
2.6 Initial ignition (only single unit version)	5
2.7 Voice guide language setting:	5
2.8 Listening priority	5
<b>Chap. 3 - Settings</b>	<b>6</b>
3.1 System settings	6
<b>Chap. 4 – Intercom</b>	<b>6</b>
4.1 Pairing	6
4.1.1: Manual pairing	6
4.1.2: Pairing to a PREVIOUS SERIES INTERCOM device	6
4.1.3: Pairing with a NON-Interphone (ANYCOM™) device	6
4.2 Two-unit intercom conversation	6
4.3 Warnings and suggestions	6
<b>Chap. 5 - Phone/GPS</b>	<b>7</b>
5.1 Pairing	7
5.2 Telephone use	7
5.3 Warnings and tips for using the phone	7
5.4 GPS	7
<b>Chap. 6 – FM RADIO</b>	<b>8</b>
6.1 Listening to FM radio	8
6.2 "FM radio" function warnings and suggestions	8
<b>Chap. 7 - Music</b>	<b>8</b>
7.1 Playing music	8
7.2 Sharing music	8
7.3 "MUSIC" function warnings and suggestions	8

## CHAP. 1 - INTRODUCTION

### 1.1 Presentation

Thank you for choosing this product. LINK Interphone is a Bluetooth® helmet device for wireless entertainment and communication between multiple motorcyclists.

LINK Interphone can be installed on most helmets with a quick attachment/detachment bracket.

LINK Interphone is certified to withstand harsh weather, with "IP67" protection level.

### 1.2 Warnings

#### BATTERY

Fully charge the battery before using the product for the first time.

Do not store the Product without charging it. Failure to do so may cause irreversible damage to the battery capacity. Charge the battery every TWO months.

#### IMPERMEABILITY

The external unit (control unit), connected to the audio kit, is classified IP67 according to the IEC60529 standard. The control unit, connected to the audio kit, can therefore be immersed in a metre of fresh water for a maximum of 30 (thirty) minutes.

Despite this classification, the device is not immune to greater stress, such as prolonged immersions or high pressure water jets.

Using the product during intense meteorological phenomena, at high speeds, may be equivalent to subjecting the product to a high pressure jet.

#### FOLLOW ALL SUGGESTIONS CAREFULLY TO AVOID DAMAGING THE DEVICE:

Do not immerse the product in fresh water which is more than a metre deep for more than 30 minutes. Do not store the product when still wet: dry it with a clean, soft cloth. Dry any water or moisture present in the connector of the control unit and/or audio kit with hot air for at least 10 minutes, so as to prevent the oxidation of the contacts.

Do not expose the product to salt water or ionised water, drinks or other liquids. If the device is exposed to liquids other than fresh water, wash the device with cold fresh water and dry it carefully with a clean, soft cloth.

Do not expose the product to high pressure water jets.

Make sure that the audio kit connector is completely inserted in the control unit. If not, complete protection against water and dust is not guaranteed.

### 1.3 Main specifications

- **Intercom:** LINK Interphone allows communication rider-passenger.
- **Telephone/GPS:** LINK Interphone can be connected simultaneously to a maximum of two devices (mobile phone/GPS navigators).
- **Radio FM:** LINK Interphone has an integrated FM-RDS receiver for the 88-108 MHz band. It is possible to store up to 8 stations.
- **Music:** LINK Interphone can play music from Bluetooth® devices, through A2DP and AVRCP profiles (smartphones, MP3 player etc.).
- **Quick touch™:** LINK Interphone features a Quick touch™ interface consisting of four keys for direct access to the functions. The single pressing of a button will activate the corresponding function, quickly and intuitively, without the need for a menu.

### 1.4 Package contents

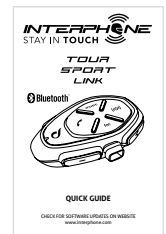
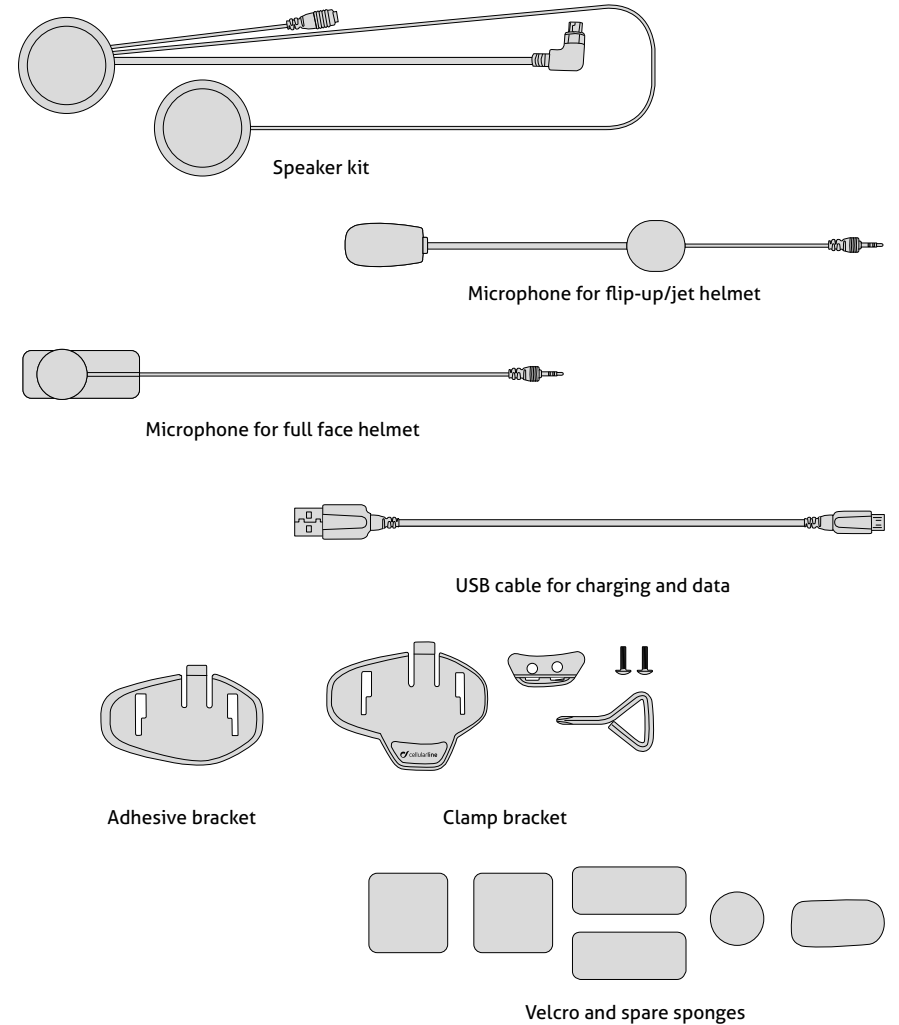

In the dual version, the material shown in the red box is present in the quantities of two pieces for each component.

## CHAP. 2 - GETTING STARTED

### 2.1 Installation instructions

Follow the sequence shown in the figures below for installation of the components.

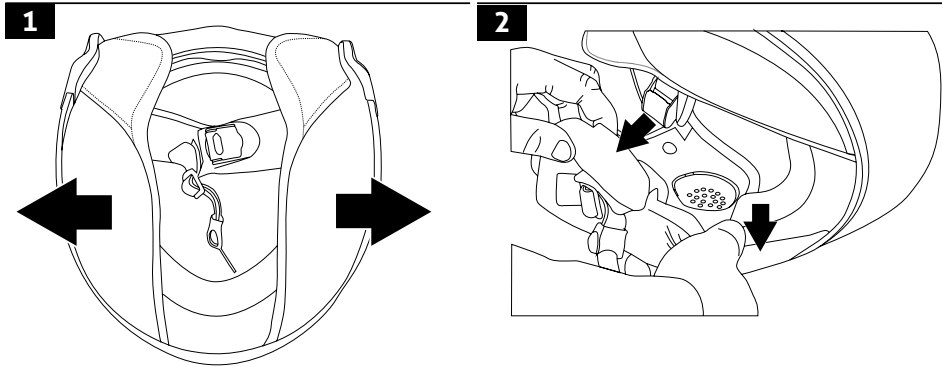

1 If possible, remove the two cushions or padding

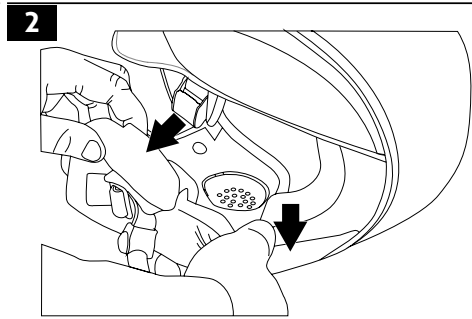

2 Locate the area in correspondence with the ear

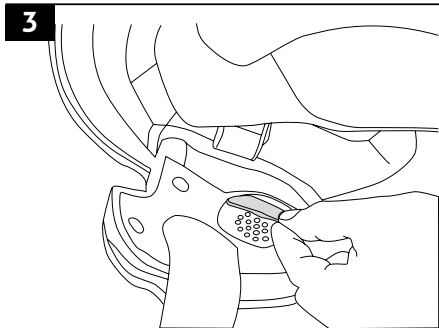

3 Position the strips of Velcro for the speakers

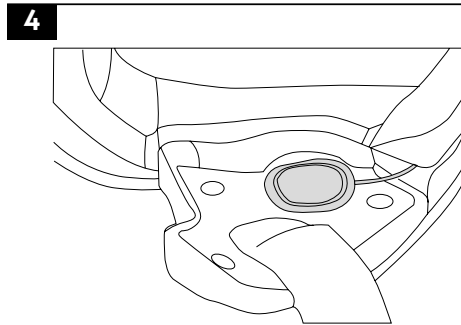

4 Place the speakers

5 Choose the microphone to use:

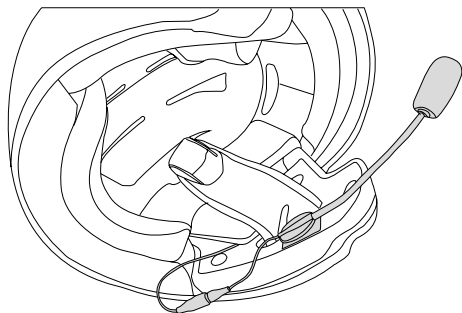

Filp-up/jet helmet

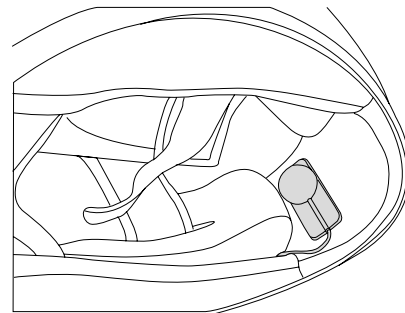

Full face helmet

### 2.2 Main commands

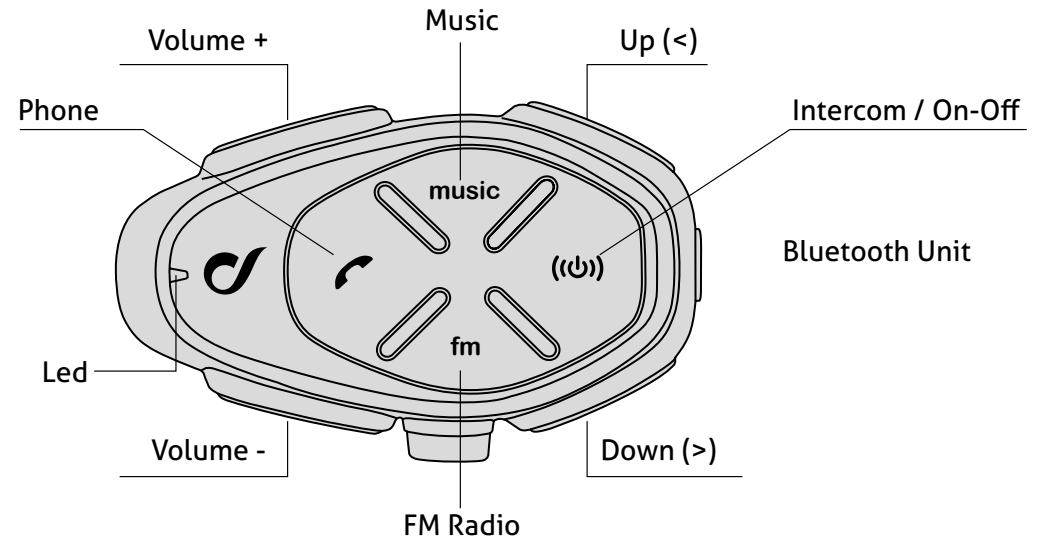

<b>Power On</b>	Press  until the blue LED comes on
<b>Power Off</b>	Hold pressed  until the red LED comes on and the device turns off
<b>Volume</b>	Press the buttons "Volume +" to increase and "Volume -" to decrease the volume.
<b>Intercom, FM radio, phone and music functions</b>	<p>Press  to directly activate (or deactivate) the intercom communication.</p> <p>Press  to directly activate (or deactivate) FM radio.</p> <p>Press  to directly access the functions of the phone.</p> <p>Press  to directly activate (or deactivate) the playing of music.</p> <p>These commands are via direct access. It is therefore possible to move from one function to another with the pressing of a button. It is not necessary to disable a function before moving on to another.</p>

### 2.3 - Battery charging

Insert the micro USB charging cable into the relevant intercom connector, as shown in the figure. Connect the cable to a standard USB charger.

LED indications:

- red LED: charging.
- mgreen LED: fully charged.

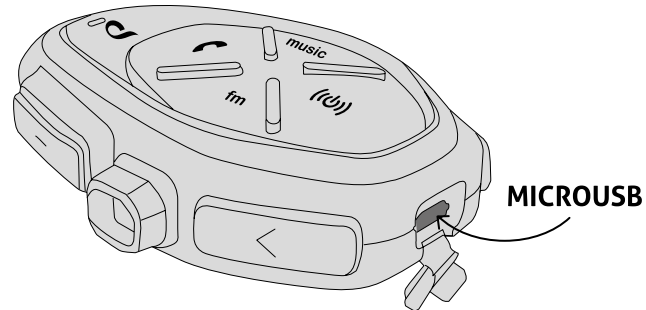

### 2.4 LED indication

Standby	The BLUE LED flashes approximately every 3 seconds.
Intercom active	The LED turns BLUE with button intensity.
Device connected with phone/GPS	The LED emits a double BLUE flash approximately every 3 seconds.
Playing music from a Bluetooth® source	The LED emits an alternate BLUE flash.
Device in pairing mode	The LED flashes RED/BLUE alternately.
Searching for another Bluetooth® device	The LED flashes RED/BLUE rapidly and alternately.
Settings mode active:	The LED lights up PURPLE.
Charging	The LED comes on RED during charging. The LED comes on GREEN when charging is complete.
Dead battery	The LED lights up RED.

### 2.5 Initial ignition (only dual unit version)

Press (Ⓜ) on both the units to switch on the devices. The units are already paired by default.

### 2.6 Initial ignition (only single unit version)

Press (Ⓜ) to turn the unit on. The device will go into "PAIRING MODE". These are the possible choices:

- pairing with Cellularline Interphone devices (see chapter 4.1).
- pairing with intercoms of other manufacturers (see chapter 4.1.4).
- phone or GPS navigation pairing (see chapter 5.1).

### 2.7 Voice guide language setting:

- With the device turned on, press and hold the UP button (<) until the third beep. The LED will be purple.
- Press + to select the desired language.
- Keep pressing the UP button (<) until the third beep to save the selection. The LED will flash blue.

### 2.8 Listening priority

The device uses the following priorities in managing the various functions:

1. Mobile phone
2. Intercom (communication with other intercoms)
3. Bluetooth® A2DP audio source (Music from smartphone/Google Maps, MP3 Player etc.)
4. FM radio

This sequence is used by the device to manage the simultaneous use of multiple functions and to choose which function to stop.

Examples:

- if a call is received while listening to music, the latter will be interrupted, automatically switching to the phone audio.
- If an intercom call is received while engaged in a phone call, the latter will not be interrupted.



## CHAP. 3 - SETTINGS

### Enter settings mode:

With the device turned on, press and hold the UP button (<) until the third beep. The LED will be purple.

### Changing the settings:

Pressing each button will change a parameter, according to the figure shown below.

### Save the selected settings:

To save the parameters set simply exit the settings mode by keeping pressed the UP button (<) until the third beep. The LED will flash blue.

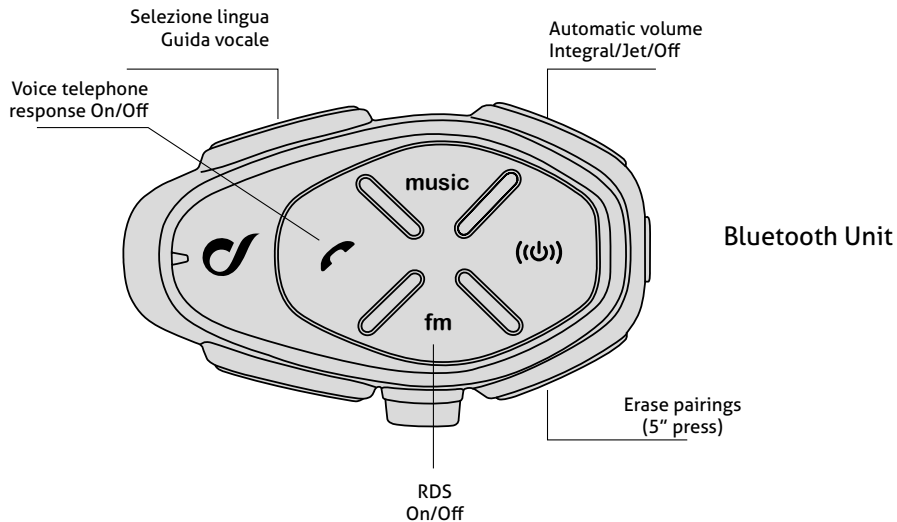

### 3.1 System settings

- **LANGUAGE SELECTION** each press of the button selects a different language for the voice guidance.
- **AUTOMATIC VOLUME: (INTEGRAL/JET/OFF)**: the device can automatically adjust the listening volume, depending on the type of helmet being used. The function can be completely disabled, in which case the user will manually adjust the volume. The maximum audio level possible can be obtained with the AUTOMATIC VOLUME OFF.
- **ERASE PAIRINGS**: press this button for 5 seconds to delete from the memory all previously paired Bluetooth devices. When erasing the pairings, exiting the Settings mode, the device will automatically enter pairing mode, shown in Chap. 2.6.
- **RDS On/Off**: this service allows the device to tune to an alternative frequency when the signal becomes too weak. Each press of the button activates/deactivates the function.
- **VOICE RESPONSE**: Where a phone call is received, it is possible to answer the call with a simple voice command. This function can be switched on/off.

## CHAP. 4 – INTERCOM

The device enables the interphone communication (function named "INTERCOM") across multiple devices in conference (several people talking at once).

### 4.1 Pairing

Before starting the communication between intercoms it is necessary to perform pairing of the various devices. This process will only need to be performed once.

Subsequently the interphone will automatically recognise the previously paired devices.

LINK Interphone is compatible with the entire INTERPHONE range (including the previous series) and with the ANYCOM function. It is also compatible with the interphones of other manufacturers.

Each LINK Interphone can be paired to a maximum of two intercoms.



If a device already has two intercoms paired, performing a third pairing will erase the pairing with the first device paired.

#### 4.1.1: Manual pairing

1. With the intercom off, on each unit, press and hold until the LED flashes red/blue.
2. Then briefly press only on one of the two units.

#### 4.1.2: Pairing to a PREVIOUS SERIES INTERCOM device

1. With the second Interphone unit (previous series) off, press and hold the central MFB button until alternate red/blue flashing of the LEDs.
2. With LINK Interphone off, press and hold until the LED flashes red/blue.
3. Press briefly on LINK Interphone.
4. After a few seconds the units will be paired and the intercom conversation will be started.

#### 4.1.3: Pairing with a NON-Interphone (ANYCOM™) device.

1. In the NON-Interphone unit, start the telephone search/pairing mode; refer to the user manual of the intercom to be paired.
2. With LINK Interphone off, press and hold until the LED flashes red/blue.
3. Press on LINK Interphone.
4. After a few seconds the units will be paired and the intercom conversation will be started.

### 4.2 Two-unit intercom conversation

1. Pair unit 1 with unit 2 (Chap. 4.1.1), operation only required the first time.
2. Press briefly on unit 1 or on unit 2.
3. Press again briefly on unit 1 or on unit 2 to interrupt the communication.

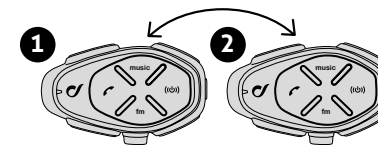

### 4.3 Warnings and suggestions

During use in three/four user conference, to ensure the best system stability, avoid connecting other Bluetooth® devices (telephones, GPS, etc.) to the intercom units.



## CHAP. 5 - PHONE/GPS

LINK Interphone can be connected to Bluetooth® devices, such as mobile phones, GPS and MP3 players. Every LINK Interphone can be connected simultaneously to up to two Bluetooth® devices (with the exception of using the three- or four-unit INTERCOM function as described in Chap. 4.3/4.4).

### 5.1 Pairing

Before starting use of LINK Interphone with these devices, it is necessary to perform pairing of the various devices. This process need only be performed once. Subsequently LINK Interphone will automatically recognise the devices previously paired and will automatically connect.





#### Pairing procedure

- 1) Activate the Bluetooth® function on the phone/GPS/MP3 (refer to the device manual for further details).
- 2) With LINK Interphone in Standby mode (BLUE LED flashing), press together the buttons  +  for 3 seconds to activate "PAIRING mode" (BLUE and RED flashing).
- 3) Start searching for new Bluetooth® devices on the mobile phone / GPS / MP3 reader
- 4) After a few seconds the device will show "F6U"/"Interphone LINK". Select this option.
- 5) If prompted for a PIN or code, enter 0000 (four zeros).
- 6) The voice guide will confirm successful pairing with the message "SUCCESSFUL PAIRING, CONNECTED TO THE PHONE". The device will go into Standby mode (blue LED flashes twice every 3 seconds).
- 7) If the Bluetooth® device requires authorisation to access the list, provide confirmation.

To pair a second device, repeat the procedure from step 1).

### 5.2 Telephone use

As specified in section 2.8, a phone call has the highest priority than any other LINK INTERPHONE function. In case of receipt of a phone call use the commands shown in the following table:

Answering a call	In case of an incoming call, press the  button or say a word out loud (voice activated response Chap. 3.1)
To end a call	To end a call press the  button or wait for the other person to end the call.
Voice call	Press  to activate the voice call
Redialling last number	Press the  button until the beep (1.5 seconds) to redial the last number.
Quick call	Press the  button until the second beep (3 seconds) to call the number set.

### 5.3 Warnings and tips for using the phone

If two different mobiles are connected at the same time, the functions "Redial last number" and "Voice call" may only be used by the first phone connected.

An Internet connection on the mobile phone may be needed to use the "Voice call".

The "Voice call" function may not be supported by your mobile phone (refer to your device manual for further details).

### 5.4 GPS

After pairing the LINK Interphone to the GPS (Chap. 5.1) it is possible to hear the voice prompts sent by the navigator. During the intercom communication the GPS (if fitted) will interrupt the conversation whenever it is necessary to transmit a voice prompt.



**Attention:** ensure the GPS is compatible with the Bluetooth® headsets. Consult the GPS user manual for further information.

LINK Interphone uses the Bluetooth® HFP profile to manage the connection to a GPS unit.

Navigators integrated within smartphones use the A2DP profile to send route directions. This profile does not allow interruption of the intercom conversation.

Navigators sold for use in cars are NOT usually equipped with Bluetooth® HFP. For that reason they cannot transmit voice prompts to Bluetooth® headsets. Consult the GPS user manual for further information.

## CHAP. 6 – FM RADIO

LINK Interphone has integrated FM radio with RDS and 8 stations that can be saved

### 6.1 Listening to FM radio

<b>Radio on/off</b>	Press the <b>fm</b> button.
<b>Forward/backward station search</b>	Press the UP/DOWN button to start the forward/backward search (from 88 MHz to 108 MHz) for a station.
<b>Memory selection</b>	Press the UP button until the beep to select the next saved station.
	Press the DOWN button until the beep to select the previous saved station.
<b>Saving a station</b>	Press the button <b>fm</b> until the beep (1.5 seconds) to save the station being listened to.
	Press the UP or DOWN button to select the memory (from no. 1 to no. 8) to save the station.
	Press the button <b>fm</b> to confirm the memory (from no. 1 to no. 8).
<b>Automatic Saving Temporary (A.T.S.™ technology)</b>	Press the button <b>fm</b> until the beep (3 seconds) to save the 8 stations with the optimum frequency Saving is temporary and the stations will be deleted when the LINK Interphone is restarted.

### 6.3 "FM radio" function warnings and suggestions.

LINK Interphone has an FM receiver with RDS. This feature is used:

- when the tuned broadcast signal becomes too weak, LINK Interphone will attempt to tune in to an alternative frequency used by the same station.



In case the signal of the current station is not weak enough to trigger the search for an alternative station, it is possible that listening will be characterised by distLINKces due to poor signal strength. FM reception is strongly influenced by the surrounding environment (electromagnetic distLINKces, natural obstacles etc.).

## CHAP. 7 - MUSIC

LINK Interphone can play music from Bluetooth® devices (smartphones, MP3 players etc.) equipped with A2DP profile. To play music it is necessary to pair the devices to LINK INTERPHONE (Chap. 5.1)

### 7.1 Playing music

<b>Play/Pause</b>	Press the <b>music</b> button to start/stop playback of music
<b>Track selection</b>	Press the UP or DOWN button to select the next or previous track.

### 7.2 Sharing music

LINK Interphone has a "SONG SHARING" function which allows music sharing with another Interphone.

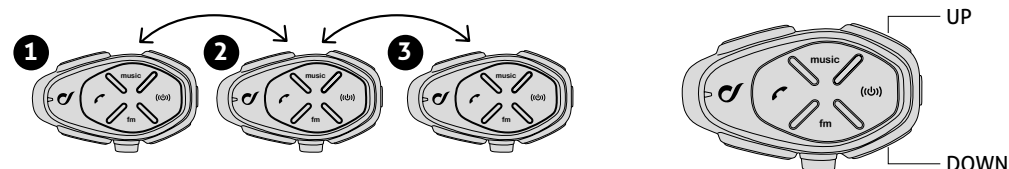

<b>Start/Stop sharing</b>	Press the UP button until the second beep to start/stop music sharing with Interphone 3.
	Press the DOWN button until the second beep to start/stop music sharing with Interphone 1.

During music sharing, by pressing the button **(iob)** it is possible to start an intercom communication.

### 7.3 "MUSIC" function warnings and suggestions.

- Only Bluetooth® devices with A2DP profile can transmit stereo music to the device.
- Only Bluetooth® devices with AVRCP profile can be controlled at a distance from the device.
- The sound quality of the music also depends on the quality of the audio source (bitrate and codec of audio files, Bluetooth® player quality etc.).

### TECHNICAL SPECIFICATIONS:

Bluetooth® compliance:	Bluetooth® v. 4.2 - Classe II
Supported Bluetooth profiles:	HFP / A2DP / AVRCP
Dimensions mm:	55x85x25
Weight:	68 g
Capacity:	Up to 10 metres
Talk time:	12 h
Stand-by time:	1000 h
Charging time:	3 h
Battery type:	Lithium-ion rechargeable





**Federal Communications Commission (FCC) Statement  
Industry Canada (IC) Statement**

15.21 You are cautioned that changes or modifications not expressly approved by the part responsible for compliance could void the user's authority to operate the equipment.

15.105(b) This equipment has been tested and found to comply with the limits for a Class B digital device, pursuant to part 15 of the FCC/IC rules. These limits are designed to provide reasonable protection against harmful interference in a residential installation. This equipment generates, uses and can radiate radio frequency energy and, if not installed and used in accordance with the instructions, may cause harmful interference to radio communications. However, there is no guarantee that interference will not occur in a particular installation. If this equipment does cause harmful interference to radio or television reception, which can be determined by turning the equipment off and on, the user is encouraged to try to correct the interference by one or more of the following measures :

- Reorient or relocate the receiving antenna.
- Increase the separation between the equipment and receiver.
- Connect the equipment into an outlet on a circuit different from that to which the receiver is connected.
- Consult the dealer or an experienced radio/TV technician for help.

This device complies with part 15 of the FCC rules and Industry Canada licence-exempt RSS standard(s)

Operation is subject to the following two conditions :

- 1)This device may not cause interference and
- 2)This device must accept any interference, including interference that may cause undesired operation of the device.

FCC/IC RF Radiation Exposure Statement :

This equipment complies with FCC/IC radiation exposure limits set forth for an uncontrolled environment. End users must follow the specific operating instructions for satisfying RF exposure compliance. This transmitter must not be co-located or operating in conjunction with any other antenna or transmitter.

SAR is measured with the device at 0 mm to the body, while transmitting at the highest certified output power level in all frequency bands of the device. The maximum SAR value is 1.75 W/kg (head/body) averaged over 10 gram of tissue.



WARNING: To prevent possible hearing damage, do not listen at high volume levels for long periods.



**EN - INSTRUCTIONS FOR THE DISPOSAL OF APPLIANCES  
FOR DOMESTIC USERS**

(Applicable in countries in the European Union and those with separate waste collection systems)  
This mark on the product or documentation indicates that this product must not be disposed of with other household waste at the end of its life. To avoid any damage to health or the environment due to improper disposal of waste, the user must separate this product from other types of waste and recycle it in a responsible manner to promote the sustainable re-use of the material resources.

Domestic users should contact the dealer where they purchased the product or the local government office for all the information regarding separate waste collection and recycling for this type of product. Corporate users should contact the supplier and verify the terms and conditions in the purchase contract. This product must not be mixed with other commercial waste.

This product has a battery that cannot be replaced by the user. Do not attempt to open the device to remove the battery as this could cause malfunctions and seriously damage the product. When disposing of the product, please contact the local waste disposal authority to remove the battery. The battery inside the device was designed to be able to be used during the entire life cycle of the product



EN - Hereby, Cellular Italia S.p.A declares that the radio equipment type BTF6 (Interphone Tour, Sport and Link) is in compliance with Directive 2014/53/EU and Directive ROHS (2011/65/EU). The user is prohibited from making any type of change or variation to the device.

Variations or changes not expressly approved by Cellular Italia S.p.A will cancel the user's authorisation to use the device.

Only update with software provided by Cellular Italia S.p.A.

Bluetooth® is a trademark owned by Bluetooth SIG, Inc.

The full text of the EU declaration of conformity is available at the following internet address: [www.cellular-line.com/it\\_it/dichiarazione-conformita/](http://www.cellular-line.com/it_it/dichiarazione-conformita/)