

# interphone **XT**

F5XT

INSTRUCTION MANUAL



 **cellularline**

[www.interphone.cellularline.com](http://www.interphone.cellularline.com)

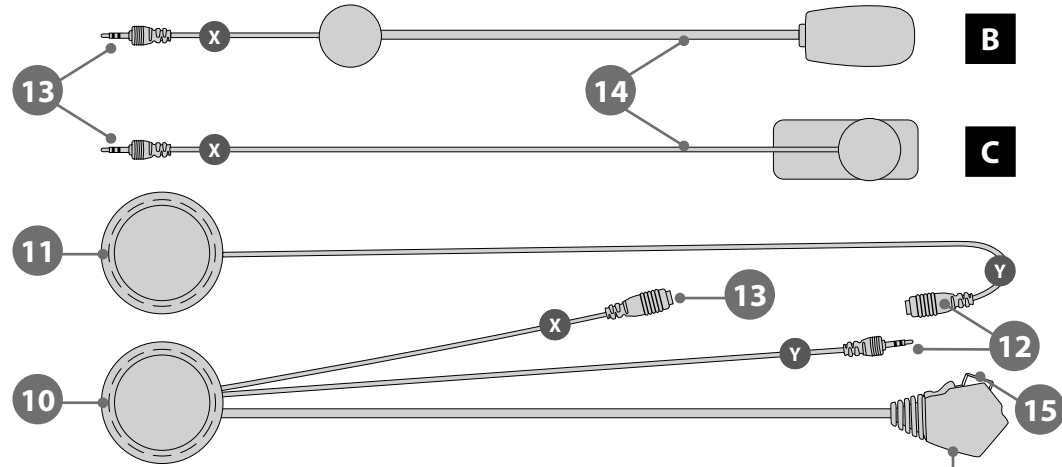
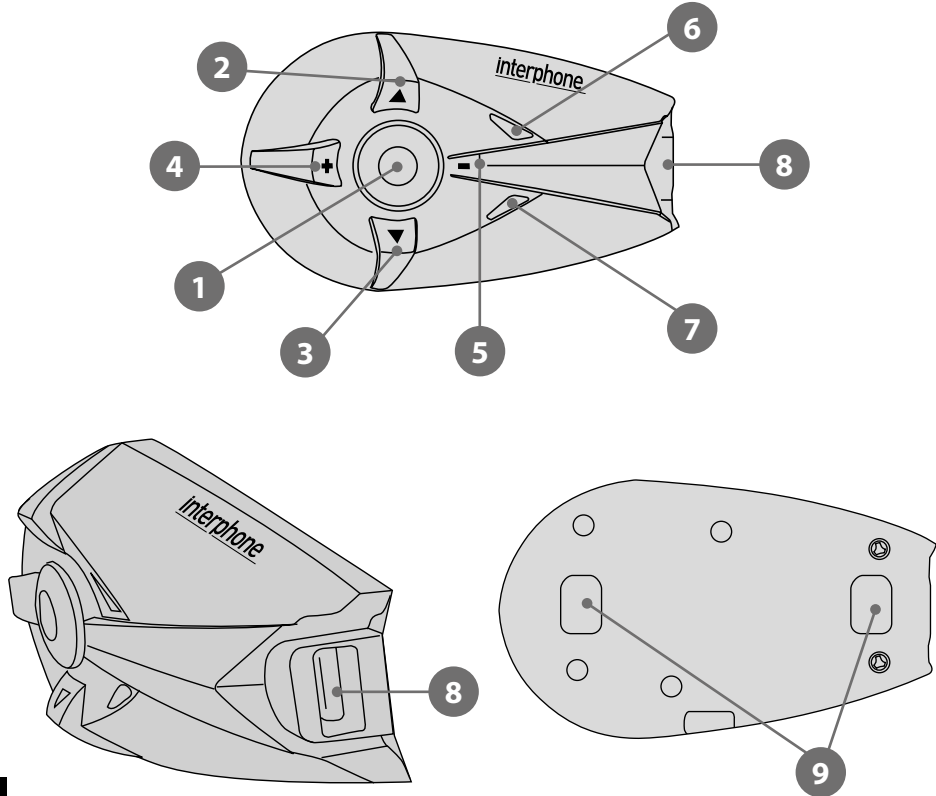

FULL-FACE

OPEN-FACE

FLIP-UP

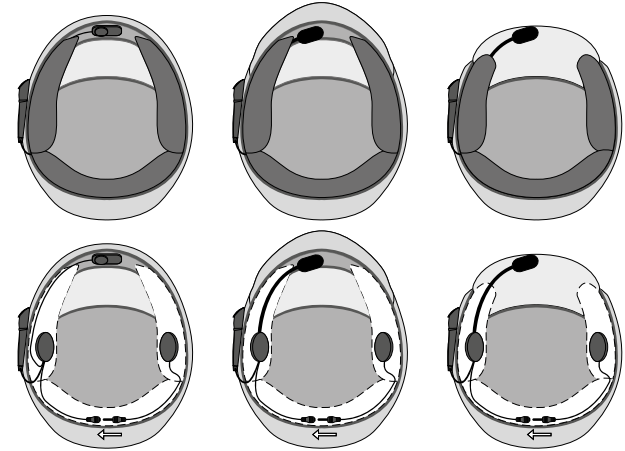

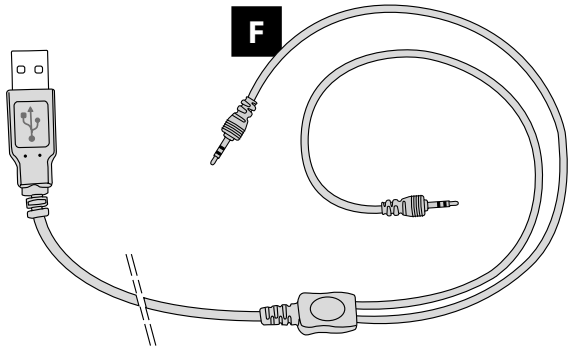

**F**

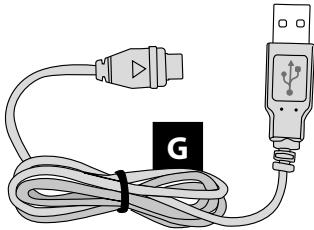

**G**

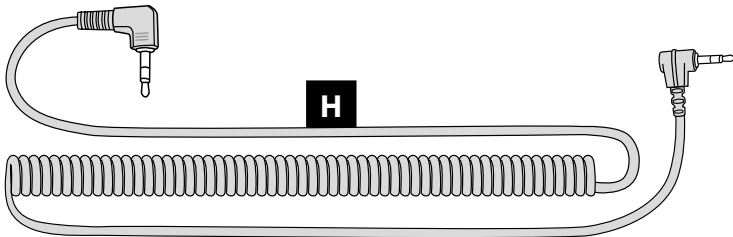

**H**



**L**



**x 4**

**I**



**x 2**

**J**

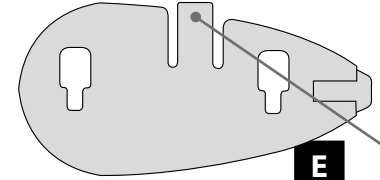
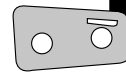

**E**

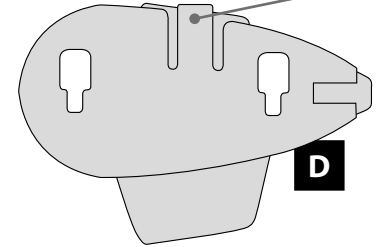

**D**

**M**

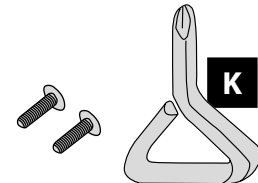

**K**



## STRINGHE VOCE GUIDA

<b>ON/OFF</b>	Interphone F cinque in spegnimento
<b>ON/OFF</b>	Interphone F cinque pronto per l'utilizzo
<b>ON/OFF</b>	connesso al telefono
<b>ON/OFF</b>	nessun telefono trovato
<b>Intercom</b>	Intercom
<b>Intercom</b>	premere tasto superiore fino al beep per connettere l'ultimo dispositivo abbinato
<b>Intercom</b>	tasto inferiore fino al beep per il precedente
<b>Intercom</b>	tasto centrale per entrambi
<b>Intercom</b>	premere brevemente tasto inferiore per il menu telefono
<b>Intercom</b>	tasto superiore per il menu impostazioni
<b>Intercom</b>	Intercom attivato, premere il tasto centrale per disconnettere
<b>Intercom</b>	nessun Intercom abbinato
<b>Intercom</b>	disconnessione intercom
<b>Intercom</b>	connessione intercom
<b>Intercom</b>	connessione intercom non riuscita
<b>Intercom</b>	intercom disconnesso
<b>Phone</b>	telefono
<b>Phone</b>	premere tasto centrale per attivare modalità chiamata
<b>Phone</b>	premere tasto inferiore per menu radio F M
<b>Phone</b>	tasto superiore per il menu Intercom
<b>Phone</b>	modalità chiamata
<b>Phone</b>	premere tasto inferiore per chiamata vocale
<b>Phone</b>	tasto superiore per richiamare l'ultimo numero
<b>Phone</b>	chiamata rifiutata
<b>Phone</b>	suoneria disattivata
<b>Phone</b>	richiama ultimo numero
<b>Phone</b>	chiamata vocale
<b>F M</b>	radio F M
<b>F M</b>	premere tasto centrale per attivare radio F M
<b>F M</b>	premere tasto inferiore per il menu musica
<b>F M</b>	tasto superiore per il menu telefono
<b>F M</b>	radio F M attivata
<b>F M</b>	premere tasto superiore o inferiore per due secondi per ricerca stazioni
<b>F M</b>	premere tasto centrale per due secondi per memorizzare la stazione

<b>F M</b>	memoria uno
<b>F M</b>	memoria due
<b>F M</b>	memoria tre
<b>F M</b>	memoria quattro
<b>F M</b>	memoria cinque
<b>F M</b>	memoria sei
<b>F M</b>	memoria sette
<b>F M</b>	memoria otto
<b>F M</b>	ricerca stazione avanti
<b>F M</b>	ricerca stazione indietro
<b>F M</b>	premere tasto superiore o inferiore per selezionare la memoria
<b>F M</b>	premere tasto centrale per memorizzare
<b>F M</b>	stazione radio salvata in
<b>F M</b>	nessuna stazione radio memorizzata
<b>A2DP</b>	musica
<b>A2DP</b>	premere tasto centrale per attivare il menu musica
<b>A2DP</b>	premere tasto inferiore per il menu AUX in
<b>A2DP</b>	tasto superiore per il menu radio F M
<b>A2DP</b>	musica attivata
<b>A2DP</b>	premere il tasto centrale per due secondi per Play o Pausa
<b>A2DP</b>	premeretasti superiore o inferiore per selezionare i brani
<b>A2DP</b>	brano seguente
<b>A2DP</b>	brano precedente
<b>A2DP</b>	pausa
<b>Auxiliary input</b>	ingresso ausiliario
<b>Auxiliary input</b>	premere tasto centrale per attivare ingresso ausiliario
<b>Auxiliary input</b>	premere tasto inferiore per il menu funzioni
<b>Auxiliary input</b>	tasto superiore per il menu musica
<b>Auxiliary input</b>	ingresso ausiliario attivato
<b>Setup Menu</b>	funzioni setup
<b>Setup Menu</b>	premere tasto centrale per attivare menu funzioni setup
<b>Setup Menu</b>	premere tasto inferiore per il menu intercom
<b>Setup Menu</b>	tasto superiore per il menu ingresso ausiliario

<b>Setup Menu</b>	menu funzioni setup attivato
<b>Setup Menu</b>	R D S attivato
<b>Setup Menu</b>	R D S disattivato
<b>Setup Menu</b>	premere tasto centrale per due secondi per cambiare la funzione R D S
<b>Setup Menu</b>	premere tasto inferiore per il menu annuncio chiamata
<b>Setup Menu</b>	tasto superiore per il menu cancellazione abbinamento
<b>Setup Menu</b>	annuncio chiamata attivato
<b>Setup Menu</b>	annuncio chiamata disattivato
<b>Setup Menu</b>	premere tasto centrale per due secondi per cambiare le funzioni menu annuncio chiamata
<b>Setup Menu</b>	premere tasto inferiore per il menu Volume automatico
<b>Setup Menu</b>	tasto superiore per il menu R D S
<b>Setup Menu</b>	volume automatico attivato
<b>Setup Menu</b>	volume automatico disattivato
<b>Setup Menu</b>	premere tasto centrale per due secondi per cambiare le funzioni Volume automatico
<b>Setup Menu</b>	premere tasto inferiore per il menu risposta vocale
<b>Setup Menu</b>	tasto superiore per il menu annuncio chiamata
<b>Setup Menu</b>	risposta vocale attivata
<b>Setup Menu</b>	risposta vocale disattivata
<b>Setup Menu</b>	premere tasto centrale per due secondi per cambiare le funzioni risposta vocale
<b>Setup Menu</b>	premere tasto inferiore per il menu cancellazione abbinamenti
<b>Setup Menu</b>	tasto superiore per il menu Volume automatico
<b>Setup Menu</b>	cancellazione abbinamento
<b>Setup Menu</b>	premere tasto centrale per due secondi per cancellare gli abbinamenti
<b>Setup Menu</b>	assistenza vocale completa
<b>Setup Menu</b>	premere tasto centrale per due secondi per cambiare le regolazioni assistenza vocale

<b>Setup Menu</b>	premere tasto inferiore per il menu R D S
<b>Setup Menu</b>	tasto superiore per il menu risposta vocale
<b>Setup Menu</b>	tutti gli abbinamenti verranno cancellati
<b>Setup Menu</b>	premere brevemente il tasto centrale per annullare l'operazione, tenere premuto per due secondi per procedere con la cancellazione abbinamenti
<b>Setup Menu</b>	abbinamenti cancellati
<b>Pairing</b>	premere tasto centrale per selezionare italiano
<b>Pairing</b>	italiano selezionato
<b>Pairing</b>	dal menu Bluetooth® del vostro telefono
<b>Pairing</b>	ricercare il dispositivo Bluetooth®
<b>Pairing</b>	e selezionare Interphone F cinque
<b>Pairing</b>	inserire il codice zero zero zero zero se necessario
<b>Pairing</b>	ricerca intercom
<b>Pairing</b>	intercom trovato
<b>Pairing</b>	abbinamento annullato
<b>Pairing</b>	reset
<b>Pairing</b>	versione
<b>Pairing</b>	intercom non trovato
<b>Pairing</b>	Abbinamento riuscito
<b>Phone</b>	Funzione non supportata dal telefono

## VOICE WIZARD PHRASES

<b>ON/OFF</b>	Interphone F5XT Powering down
<b>ON/OFF</b>	Interphone F5XT Ready
<b>ON/OFF</b>	connected to phone
<b>ON/OFF</b>	no phone found
<b>Intercom</b>	Intercom
<b>Intercom</b>	Press up button until the beep to connect the last paired intercom
<b>Intercom</b>	Down button until the beep for the previous
<b>Intercom</b>	Centre button until the beep for both
<b>Intercom</b>	Short press down button for Phone menu
<b>Intercom</b>	up button for Setup menu
<b>Intercom</b>	Intercom Active, press centre button to disconnect
<b>Intercom</b>	no intercom paired
<b>Intercom</b>	disconnecting intercom
<b>Intercom</b>	Connecting to intercom
<b>Intercom</b>	intercom connection failed
<b>Intercom</b>	intercom disconnected
<b>Phone</b>	Phone
<b>Phone</b>	Press centre button to select Phone menu
<b>Phone</b>	press down button for FM menu
<b>Phone</b>	up button for Intercom menu
<b>Phone</b>	Phone mode
<b>Phone</b>	Press down button to voice dial
<b>Phone</b>	up button to redial
<b>Phone</b>	Call Rejected
<b>Phone</b>	Ring Muted
<b>Phone</b>	Redialling last number
<b>Phone</b>	Voice Dial
<b>FM</b>	FM
<b>FM</b>	Press centre button to activate FM
<b>FM</b>	press down button for music streaming menu
<b>FM</b>	up button for Phone menu
<b>FM</b>	FM Active
<b>FM</b>	press up or down button until the beep to Scan
<b>FM</b>	press centre button until the beep to Store
<b>FM</b>	Memory one
<b>FM</b>	Memory two

<b>FM</b>	Memory three
<b>FM</b>	Memory four
<b>FM</b>	Memory five
<b>FM</b>	Memory six
<b>FM</b>	Memory seven
<b>FM</b>	Memory eight
<b>FM</b>	Scan up
<b>FM</b>	Scan down
<b>FM</b>	Press up or down button to select memory
<b>FM</b>	Press Centre Button to store
<b>FM</b>	F M station stored to
<b>FM</b>	No station stored
<b>A2DP</b>	Music Streaming
<b>A2DP</b>	Press centre button to select music streaming menu
<b>A2DP</b>	press down button for Auxiliary input menu
<b>A2DP</b>	up button for FM menu
<b>A2DP</b>	Music Streaming Active
<b>A2DP</b>	press centre button until the beep to play or pause
<b>A2DP</b>	Press up or down button to select a track
<b>A2DP</b>	Next
<b>A2DP</b>	Previous
<b>A2DP</b>	Music Paused
<b>Auxiliary input</b>	Auxiliary input
<b>Auxiliary input</b>	Press centre button to activate Auxiliary input
<b>Auxiliary input</b>	press down button for Setup menu
<b>Auxiliary input</b>	up button for music streaming menu
<b>Auxiliary input</b>	Auxiliary input Active
<b>Setup Menu</b>	Setup
<b>Setup Menu</b>	Press centre button to select Setup menu
<b>Setup Menu</b>	press down button for Intercom menu
<b>Setup Menu</b>	up button for Auxiliary input menu
<b>Setup Menu</b>	Setup Active
<b>Setup Menu</b>	R D S ON
<b>Setup Menu</b>	R D S OFF
<b>Setup Menu</b>	Press centre button until the beep to change R D S settings
<b>Setup Menu</b>	Press down button for Caller ID settings

<b>Setup Menu</b>	Up button for Erase Pairings menu
<b>Setup Menu</b>	Caller I D ON
<b>Setup Menu</b>	Caller I D OFF
<b>Setup Menu</b>	Press centre button until the beep to change Caller I D settings
<b>Setup Menu</b>	Press down button for Volume Control settings
<b>Setup Menu</b>	Up button for R D S settings
<b>Setup Menu</b>	Automatic Volume Control ON
<b>Setup Menu</b>	Automatic Volume Control OFF
<b>Setup Menu</b>	Press centre button until the beep to change Volume Control settings
<b>Setup Menu</b>	Press down button for Voice answer settings
<b>Setup Menu</b>	Up button for Caller I D settings
<b>Setup Menu</b>	Voice answer ON
<b>Setup Menu</b>	Voice answer OFF
<b>Setup Menu</b>	Press centre button until the beep to change Voice answer settings
<b>Setup Menu</b>	Press down button for Erase Pairings menu
<b>Setup Menu</b>	Up button for Volume Control settings
<b>Setup Menu</b>	Erase Pairings
<b>Setup Menu</b>	Press centre button until the beep to erase pairings
<b>Setup Menu</b>	Full Vocal Helps
<b>Setup Menu</b>	Press centre button until the beep to change vocal helps settings
<b>Setup Menu</b>	Press down button for RDS settings
<b>Setup Menu</b>	Up button for Voice answer settings
<b>Setup Menu</b>	All pairings will be erased
<b>Setup Menu</b>	Short press centre button to cancel, press until the beep to erase
<b>Setup Menu</b>	Pairings erased
<b>Pairing</b>	Press on centre button to select British English
<b>Pairing</b>	British English selected
<b>Pairing</b>	From phone Bluetooth® menu
<b>Pairing</b>	Search for devices
<b>Pairing</b>	And select Interphone F5XT
<b>Pairing</b>	Enter Pin code 0000 if requested
<b>Pairing</b>	Intercom Device Search

<b>Pairing</b>	Intercom Found
<b>Pairing</b>	Pairing cancelled
<b>Pairing</b>	Factory reset
<b>Pairing</b>	Version
<b>Pairing</b>	No intercom found
<b>Pairing</b>	Pairing successful
<b>Phone</b>	Not supported by phone

## PHRASES VOIX DE GUIDAGE

<b>ON/OFF</b>	Interphone F cinq éteint
<b>ON/OFF</b>	Interphone F cinq prêt à être utilisé
<b>ON/OFF</b>	Votre téléphone est connecté
<b>ON/OFF</b>	Aucun téléphone détecté
<b>Intercom</b>	Intercom
<b>Intercom</b>	appuyez sur la touche du haut jusqu'au beep pour connecter le dernier intercom pairé
<b>Intercom</b>	la touche du bas jusqu'au beep pour l'avant dernier
<b>Intercom</b>	la touche centrale jusqu'au beep pour les deux
<b>Intercom</b>	Appuyez sur la touche du bas une seconde pour le menu "téléphone"
<b>Intercom</b>	la touche du haut pour le menu "Réglages"
<b>Intercom</b>	Intercom actif, appuyez sur la touche centrale pour déconnecter
<b>Intercom</b>	Aucun intercom pairé
<b>Intercom</b>	déconnexion intercom
<b>Intercom</b>	Connexion intercom
<b>Intercom</b>	échec de connexion intercom
<b>Intercom</b>	intercom déconnecté
<b>Phone</b>	téléphone
<b>Phone</b>	Appuyez sur la touche centrale pour sélectionner le menu téléphone
<b>Phone</b>	la touche du bas pour le menu "FM"
<b>Phone</b>	la touche du haut pour le menu "Intercom"
<b>Phone</b>	Mode téléphone
<b>Phone</b>	Appuyer la touche du haut pour rappeler le dernier numéro
<b>Phone</b>	Appuyer la touche du bas pour une numérotation vocale
<b>Phone</b>	Appel refusé
<b>Phone</b>	Sonnerie désactivée
<b>Phone</b>	Rappel du dernier numéro en cours
<b>Phone</b>	numérotation vocale
<b>FM</b>	FM
<b>FM</b>	Appuyez sur la touche centrale pour activer la FM
<b>FM</b>	la touche du bas pour le menu "musique"
<b>FM</b>	la touche du haut pour le menu "téléphone"

<b>FM</b>	FM activée
<b>FM</b>	Appuyez la touche du haut ou du bas jusqu'au beep pour rechercher une station
<b>FM</b>	Appuyez sur la touche centrale jusqu'au beep pour mémoriser une station
<b>FM</b>	Mémoire une
<b>FM</b>	Mémoire deux
<b>FM</b>	Mémoire trois
<b>FM</b>	Mémoire quatre
<b>FM</b>	Mémoire cinq
<b>FM</b>	Mémoire six
<b>FM</b>	Mémoire sept
<b>FM</b>	Mémoire huit
<b>FM</b>	Recherche station suivante
<b>FM</b>	Recherche station précédente
<b>FM</b>	appuyez sur la touche du haut ou du bas pour sélectionner la Mémoire
<b>FM</b>	Appuyez sur la touche centrale pour mémoriser
<b>FM</b>	Station FM mémorisée dans la
<b>FM</b>	Aucune Station mémorisée
<b>A2DP</b>	musique
<b>A2DP</b>	Appuyez sur la touche centrale pour sélectionner le menu musique
<b>A2DP</b>	la touche du bas pour le menu "Entrée Auxiliaire"
<b>A2DP</b>	la touche du haut pour le menu "FM"
<b>A2DP</b>	musique activée
<b>A2DP</b>	Appuyez sur la touche centrale jusqu'au beep pour lecture et pause
<b>A2DP</b>	appuyez sur la touche du haut ou la touche du bas pour changer de piste audio
<b>A2DP</b>	Suivant
<b>A2DP</b>	Précédent
<b>A2DP</b>	Pause
<b>Auxiliary input</b>	Entrée Auxiliaire
<b>Auxiliary input</b>	Appuyez sur la touche centrale pour activer l'entrée Auxiliaire
<b>Auxiliary input</b>	la touche du bas pour le menu "Réglages"
<b>Auxiliary input</b>	la touche du haut pour le menu "musique"

<b>Auxiliary input</b>	Entrée Auxiliaire activée
<b>Setup Menu</b>	Réglages
<b>Setup Menu</b>	Appuyez sur la touche centrale pour sélectionner le menu Réglages
<b>Setup Menu</b>	la touche du bas pour le menu "Intercom"
<b>Setup Menu</b>	la touche du haut pour le menu "Entrée Auxiliaire"
<b>Setup Menu</b>	Menu Réglages activé
<b>Setup Menu</b>	R D S Activé
<b>Setup Menu</b>	R D S Désactivé
<b>Setup Menu</b>	Appuyez sur la touche centrale jusqu'au beep pour changer le réglage R D S
<b>Setup Menu</b>	la touche du bas pour le menu "Annonce du nom de l'appelant"
<b>Setup Menu</b>	la touche du haut pour le menu "Effacer les pairages"
<b>Setup Menu</b>	Annonce du nom de l'appelant activée
<b>Setup Menu</b>	Annonce du nom de l'appelant désactivée
<b>Setup Menu</b>	Appuyez sur la touche centrale jusqu'au beep pour changer le réglage "Annonce du nom de l'appelant"
<b>Setup Menu</b>	la touche du bas pour le menu "Volume Automatique"
<b>Setup Menu</b>	la touche du haut pour le menu "R D S"
<b>Setup Menu</b>	Volume Automatique Activé
<b>Setup Menu</b>	Volume Automatique désactivé
<b>Setup Menu</b>	Appuyez sur la touche centrale jusqu'au beep pour changer le réglage "Volume Automatique"
<b>Setup Menu</b>	la touche du bas pour le menu "Décrochage Vocal"
<b>Setup Menu</b>	la touche du haut pour le menu "Annonce du nom de l'appelant"
<b>Setup Menu</b>	Décrochage Vocal Activé
<b>Setup Menu</b>	Décrochage Vocal Désactivé
<b>Setup Menu</b>	Appuyez sur la touche centrale jusqu'au beep pour changer le réglage "Décrochage Vocal"
<b>Setup Menu</b>	la touche du bas pour le menu "Effacer les pairages"

<b>Setup Menu</b>	la touche du haut pour le menu "Volume Automatique"
<b>Setup Menu</b>	Effacer les pairages
<b>Setup Menu</b>	Appuyez sur la touche centrale jusqu'au beep pour effacer les pairages
<b>Setup Menu</b>	Assistance vocal complet
<b>Setup Menu</b>	Appuyez sur la touche centrale jusqu'au beep pour changer le réglage "Assistance vocal"
<b>Setup Menu</b>	la touche du bas pour le menu "R D S"
<b>Setup Menu</b>	la touche du haut pour le menu "Décrochage Vocal"
<b>Setup Menu</b>	Tous les pairages seront effacés
<b>Setup Menu</b>	Appuyez une seconde sur la touche centrale pour annuler, jusqu'au beep pour effacer pairages effacés
<b>Pairing</b>	Appuyez sur la touche centrale pour sélectionner le Français
<b>Pairing</b>	Français sélectionné
<b>Pairing</b>	Depuis le menu Bluetooth® de votre téléphone
<b>Pairing</b>	recherchez les accessoires Bluetooth®
<b>Pairing</b>	et sélectionnez Interphone F cinq.
<b>Pairing</b>	entrez le code zéro zéro zéro zéro si nécessaire
<b>Pairing</b>	Recherche Intercom
<b>Pairing</b>	Intercom détecté
<b>Pairing</b>	Pairage annulé
<b>Pairing</b>	Réglages d'usine
<b>Pairing</b>	Version
<b>Pairing</b>	Aucun intercom détecté
<b>Pairing</b>	Le pairage est réussi
<b>Phone</b>	Fonction non accessible sur votre téléphone

## CADENAS DE VOZ DE GUÍA

<b>ON/OFF</b>	Interfono F cinco apagado
<b>ON/OFF</b>	Interfono F cinco está listo
<b>ON/OFF</b>	Conectado al teléfono
<b>ON/OFF</b>	No se ha encontrado ningún teléfono
<b>Intercom</b>	Intercomunicador
<b>Intercom</b>	Pulse el botón arriba hasta escuchar el pitido para conectar el último intercomunicador emparejado
<b>Intercom</b>	el botón abajo hasta escuchar el pitido para el penúltimo
<b>Intercom</b>	el botón central hasta escuchar el pitido para los dos
<b>Intercom</b>	Pulse brevemente el botón abajo para acceder al menú Teléfono
<b>Intercom</b>	el botón arriba para acceder al menú Ajustes
<b>Intercom</b>	Intercomunicador activo, pulse el botón central para desconectar
<b>Intercom</b>	Ningún intercomunicador emparejado
<b>Intercom</b>	Desconectando intercomunicador
<b>Intercom</b>	Conectando al intercomunicador
<b>Intercom</b>	Error de conexión del intercomunicador
<b>Intercom</b>	Intercomunicador desconectado
<b>Phone</b>	Teléfono
<b>Phone</b>	Pulse el botón central para seleccionar el menú Teléfono
<b>Phone</b>	el botón abajo para acceder al menú FM
<b>Phone</b>	el botón abajo para acceder al menú Intercomunicador
<b>Phone</b>	Modo teléfono
<b>Phone</b>	Pulse el botón arriba para volver a marcar el último número
<b>Phone</b>	Pulse el botón abajo para la marcación por voz
<b>Phone</b>	Llamada rechazada
<b>Phone</b>	Modo Silencio
<b>Phone</b>	Marcando último número
<b>Phone</b>	Marcación por voz
<b>FM</b>	FM
<b>FM</b>	Pulse el botón central para activar la FM
<b>FM</b>	el botón abajo para acceder al menú Música

<b>FM</b>	el botón arriba para acceder al menú Teléfono
<b>FM</b>	FM activada
<b>FM</b>	Pulse el botón arriba o abajo hasta el pitido para buscar emisoras
<b>FM</b>	Pulse el botón central hasta el pitido para memorizar una emisora
<b>FM</b>	Memoria uno
<b>FM</b>	Memoria dos
<b>FM</b>	Memoria tres
<b>FM</b>	Memoria cuatro
<b>FM</b>	Memoria cinco
<b>FM</b>	Memoria seis
<b>FM</b>	Memoria siete
<b>FM</b>	Memoria ocho
<b>FM</b>	Buscar emisora hacia adelante
<b>FM</b>	Buscar emisora hacia atrás
<b>FM</b>	Pulse el botón arriba o abajo para seleccionar la memoria
<b>FM</b>	Pulse el botón central para memorizar
<b>FM</b>	Emisora de FM memorizada en
<b>FM</b>	Ninguna emisora memorizada
<b>A2DP</b>	Música
<b>A2DP</b>	Pulse el botón central para seleccionar el menú Música
<b>A2DP</b>	el botón abajo para acceder al menú Entrada auxiliar
<b>A2DP</b>	el botón arriba para acceder al menú FM
<b>A2DP</b>	Música activada
<b>A2DP</b>	Pulse el botón central hasta el pitido para reproducir o poner en pausa
<b>A2DP</b>	Pulse los botones arriba o abajo para cambiar la canción
<b>A2DP</b>	Siguiente
<b>A2DP</b>	Anterior
<b>A2DP</b>	Música en pausa
<b>Auxiliary input</b>	Entrada auxiliar
<b>Auxiliary input</b>	Pulse el botón central para activar la Entrada auxiliar
<b>Auxiliary input</b>	el botón abajo para acceder al menú Ajustes

<b>Auxiliary input</b>	el botón arriba para acceder al menú Música
<b>Auxiliary input</b>	Entrada auxiliar activada
<b>Setup Menu</b>	Ajustes
<b>Setup Menu</b>	Pulse el botón central para seleccionar el menú Ajustes
<b>Setup Menu</b>	el botón abajo para acceder al menú Intercomunicador
<b>Setup Menu</b>	el botón arriba para el menú Entrada Auxiliar
<b>Setup Menu</b>	Menú Ajustes activado
<b>Setup Menu</b>	RDS activado
<b>Setup Menu</b>	RDS desactivado
<b>Setup Menu</b>	Pulse el botón central hasta el pitido para cambiar los ajustes de RDS
<b>Setup Menu</b>	el botón abajo para acceder al menú identificación de llamada
<b>Setup Menu</b>	el botón arriba para acceder al menú Borrar los emparejamientos
<b>Setup Menu</b>	Identificación de llamada activada
<b>Setup Menu</b>	Identificación de llamada desactivada
<b>Setup Menu</b>	Pulse el botón central hasta el pitido para cambiar los ajustes de identificación de llamada
<b>Setup Menu</b>	el botón abajo para acceder al menú volumen automático
<b>Setup Menu</b>	el botón arriba para acceder al menú RDS
<b>Setup Menu</b>	Volumen automático activado
<b>Setup Menu</b>	Volumen automático desactivado
<b>Setup Menu</b>	Pulse el botón central hasta el pitido para cambiar los ajustes de volumen automático
<b>Setup Menu</b>	el botón abajo para acceder al menú respuesta por voz
<b>Setup Menu</b>	el botón arriba para acceder al menú identificación de llamada
<b>Setup Menu</b>	respuesta de voz activada
<b>Setup Menu</b>	respuesta de voz desactivada
<b>Setup Menu</b>	Pulse el botón central hasta el pitido para cambiar los ajustes de respuesta de voz
<b>Setup Menu</b>	el botón abajo para acceder al menú Borrar los emparejamientos

<b>Setup Menu</b>	el botón arriba para acceder al menú volumen automático
<b>Setup Menu</b>	Borrar los emparejamientos
<b>Setup Menu</b>	Pulse el botón central hasta el pitido para borrar los emparejamientos
<b>Setup Menu</b>	soporte de voz completa
<b>Setup Menu</b>	Pulse el botón central hasta el pitido para cambiar los ajustes de soporte de voz
<b>Setup Menu</b>	el botón abajo para acceder al menú RDS
<b>Setup Menu</b>	el botón arriba para acceder al menú control por voz
<b>Setup Menu</b>	Se borrarán todos los emparejamientos
<b>Setup Menu</b>	Pulse brevemente el botón central para cancelar, hasta el pitido para borrar
<b>Setup Menu</b>	Emparejamientos borrados
<b>Pairing</b>	Pulse el botón central para seleccionar español
<b>Pairing</b>	Español seleccionado
<b>Pairing</b>	Desde el menú Bluetooth® del teléfono
<b>Pairing</b>	busque dispositivos Bluetooth®
<b>Pairing</b>	y seleccione Interfono F cinco
<b>Pairing</b>	Si se solicita, introduzca el código PIN zero zero zero
<b>Pairing</b>	Búsqueda de dispositivo intercomunicador
<b>Pairing</b>	Intercomunicador encontrado
<b>Pairing</b>	Emparejamientos cancelado
<b>Pairing</b>	Ajustes de fábrica
<b>Pairing</b>	Versión
<b>Pairing</b>	No se ha encontrado ningún intercomunicador
<b>Pairing</b>	Enlazado con el teléfono
<b>Phone</b>	No es compatible con el teléfono



## SPRACHANLEITUNGSSÄTZE

<b>ON/OFF</b>	Interphone F5XT wird ausgeschaltet
<b>ON/OFF</b>	Interphone F5XT bereit
<b>ON/OFF</b>	Ans Telefon angeschlossen
<b>ON/OFF</b>	Kein Telefon gefunden
<b>Intercom</b>	Intercom
<b>Intercom</b>	Oben knopf bis der Signalton zum letzten gekoppelt Intercom verbinden
<b>Intercom</b>	nach unten bis der Signalton für das abgelaufene
<b>Intercom</b>	Und mitttelknopf bis der Signalton für beide
<b>Intercom</b>	Unten knopf kurz drücken für Telefon-Menü
<b>Intercom</b>	und nach oben für Setup-Menü
<b>Intercom</b>	Intercom aktiv, zu getrennt Mittelknopf drücken
<b>Intercom</b>	Kein Intercom Pairing
<b>Intercom</b>	Intercom wird getrennt
<b>Intercom</b>	Intercom wird angeschlossen
<b>Intercom</b>	Intercomverbindung fehlgeschlagen
<b>Intercom</b>	Intercom ist abgetrennt
<b>Phone</b>	Telefon
<b>Phone</b>	Mittelknopf für Telefon-Menü drücken
<b>Phone</b>	nach unten für FM-Menü
<b>Phone</b>	und nach oben für Intercom-Menü
<b>Phone</b>	Telefon-Modus
<b>Phone</b>	Nach unten für Sprechwahl
<b>Phone</b>	nach oben für Wahlwiederholung drücken
<b>Phone</b>	Anruf abgelehnt
<b>Phone</b>	Klingelton ausgeschaltet
<b>Phone</b>	Wahlwiederholung der letzten Nummer
<b>Phone</b>	Sprachwahl
<b>FM</b>	FM
<b>FM</b>	Mittelknopf zum Aktivieren von FM drücken
<b>FM</b>	nach unten für Musikstreaming Menü
<b>FM</b>	nach oben für Telefon-Menü
<b>FM</b>	FM aktiv
<b>FM</b>	Zum Scannen bis der Signalton nach oben oder unten drücken
<b>FM</b>	Zum Speichern bis der Signalton lang Mittelknopf drücken
<b>FM</b>	Speicher Eins

<b>FM</b>	Speicher Zwei
<b>FM</b>	Speicher Drei
<b>FM</b>	Speicher Vier
<b>FM</b>	Speicher Fünf
<b>FM</b>	Speicher Sechs
<b>FM</b>	Speicher Sechs
<b>FM</b>	Speicher Acht
<b>FM</b>	Nach oben Scannen
<b>FM</b>	Nach unten Scannen
<b>FM</b>	Zur Speicher-Wahl nach oben oder unten drücken
<b>FM</b>	zum Speichern Mittelknopf drücken
<b>FM</b>	FM Station gespeichert in
<b>FM</b>	Keine Station gespeichert
<b>A2DP</b>	Musikstreaming
<b>A2DP</b>	Mittelknopf zur Wahl des Musikstreaming-Menüs drücken
<b>A2DP</b>	nach unten für Hilfeingang-Menü
<b>A2DP</b>	und nach oben für FM-Menü
<b>A2DP</b>	Musikstreaming aktiv
<b>A2DP</b>	Mittelknopf bis der Signalton für Spielen oder Pause drücken.
<b>A2DP</b>	Nach oben oder unten zur Wahl eines Titels drücken
<b>A2DP</b>	Weiter
<b>A2DP</b>	Zurück
<b>A2DP</b>	Musik pausiert
<b>Auxiliary input</b>	Hilfeingang
<b>Auxiliary input</b>	Mittelknopf zum Aktivieren des Hilfeingangs drücken
<b>Auxiliary input</b>	nach unten für Setup-Menü
<b>Auxiliary input</b>	nach oben für Musikstreaming-Menü
<b>Auxiliary input</b>	Hilfeingang aktiv
<b>Setup Menu</b>	Setup
<b>Setup Menu</b>	Mittelknopf zur Wahl des Setup-Menüs drücken
<b>Setup Menu</b>	nach unten für Intercom-Menü
<b>Setup Menu</b>	nach oben für Hilfeingang-Menü
<b>Setup Menu</b>	Setup aktiv
<b>Setup Menu</b>	RDS an

<b>Setup Menu</b>	RDS aus
<b>Setup Menu</b>	Mittelknopf bis der Signalton zum Ändern der RDS-Einstellungen drücken
<b>Setup Menu</b>	nach unten für die Anrufererkennungseinstellungen
<b>Setup Menu</b>	nach oben zum Löschen des Pairing-Menüs
<b>Setup Menu</b>	Anrufererkennung an
<b>Setup Menu</b>	Anrufererkennung aus
<b>Setup Menu</b>	Mittelknopf bis der Signalton zum Ändern der Anrufererkennungseinstellungen drücken
<b>Setup Menu</b>	nach unten für die Lautstärkereglungseinstellungen
<b>Setup Menu</b>	und nach oben für die RDS-Einstellungen
<b>Setup Menu</b>	Automatische Lautstärkenregelung an
<b>Setup Menu</b>	Automatische Lautstärkenregelung aus
<b>Setup Menu</b>	Mittelknopf bis der Signalton zum Ändern der Lautstärkereglungseinstellungen
<b>Setup Menu</b>	nach unten für die Sprechantwort-Einstellungen
<b>Setup Menu</b>	und nach oben für die Anrufererkennungseinstellungen
<b>Setup Menu</b>	Sprechantwort an
<b>Setup Menu</b>	Sprechantwort aus
<b>Setup Menu</b>	Mittelknopf bis der Signalton zum Ändern der Sprechantwort-Einstellungen drücken
<b>Setup Menu</b>	nach unten zum Löschen des Pairing-Menüs
<b>Setup Menu</b>	und nach oben für die Lautstärkereglungseinstellungen
<b>Setup Menu</b>	Pairings löschen
<b>Setup Menu</b>	Mittelknopf bis der Signalton zum Löschen der Pairings drücken
<b>Setup Menu</b>	Vollständige Sprachführung
<b>Setup Menu</b>	Die Mittel Taste für zwei Sekunden drücken, um die Sprachführungseinstellungen zu ändern
<b>Setup Menu</b>	nach unten für die RDS-Einstellungen
<b>Setup Menu</b>	und nach oben für die Sprechantwort-Einstellungen
<b>Setup Menu</b>	Alle Pairings werden gelöscht

<b>Setup Menu</b>	Mittelknopf kurz drücken zum Stornieren, bis der Signalton drücken zum Löschen
<b>Setup Menu</b>	Pairings gelöscht
<b>Pairing</b>	Mittelknopf zur Wahl von Deutsch drücken
<b>Pairing</b>	Deutsch gewählt
<b>Pairing</b>	Über das Telefon-Bluetooth®-Menü
<b>Pairing</b>	nach Geräten suchen
<b>Pairing</b>	und Interphone F5XT wählen
<b>Pairing</b>	Nach Hinweis PIN-Code 0000 eingeben
<b>Pairing</b>	Intercom-Gerät-Suche
<b>Pairing</b>	Intercom gefunden
<b>Pairing</b>	Pairing storniert
<b>Pairing</b>	Auf Werkseinstellung zurückgehen
<b>Pairing</b>	Version
<b>Pairing</b>	Kein Intercom gefunden
<b>Pairing</b>	Pairing erfolgreich
<b>Phone</b>	Wird nicht vom Telefon unterstützt

## TABLE OF CONTENTS

<b>PRESENTATION</b> .....	19
<b>CONTENTS OF THE PACKAGE</b> .....	19
<b>PRODUCT DESCRIPTION</b> .....	19
<b>CARE AND MAINTENANCE</b> .....	19
<b>1.0 PREPARATION/ASSEMBLY</b> .....	20
1.1 Mounting the bracket on the helmet .....	20
1.2 Audio section .....	21
1.3 Charging .....	21
1.4 Connecting the F5XT module on the helmet .....	22
1.5 Connecting the F5XT module with the audio kit ..	22
1.6 Removing the F5XT module from the helmet .....	22
1.7 Turning on the F5XT module .....	22
1.8 Turning off the F5XT module .....	22
1.9 Adjusting the listening volume .....	22
<b>2.0 PAIRING</b> .....	22
2.1 Procedure for pairing with Bluetooth® devices .....	23
2.2 Procedure for pairing two InterphoneF5XTs .....	24
2.3 Procedure for pairing three InterphoneF5XTs .....	25
2.4 Procedure for "Conference" pairing of four InterphoneF5XTs .....	25
<b>3.0 NOTES AND GENERAL RECOMMENDATIONS</b> .....	26
3.1 Device shutdown .....	26
3.2 Range .....	26
3.3 Electromagnetic compatibility .....	26
3.4 Operating precautions .....	26
3.5 Voice wizard phrases .....	26

### F5XT VOICE MENU DIAGRAM

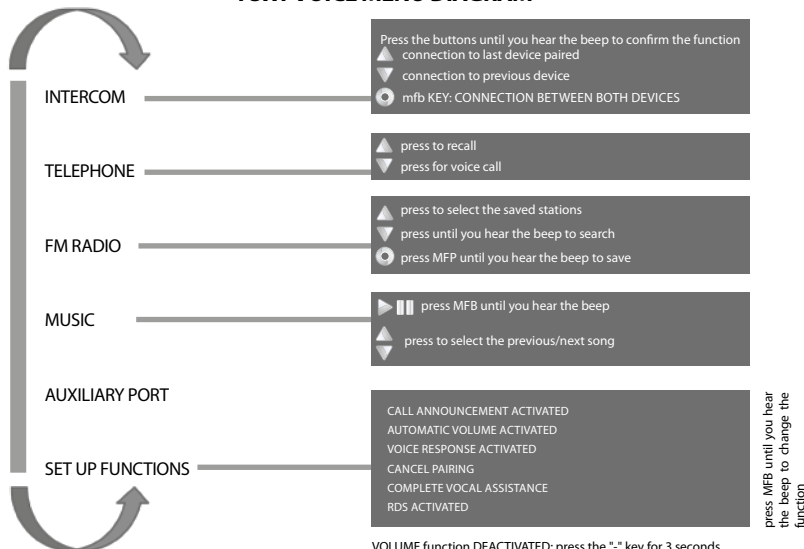

### Presentation

**INTERPHONEF5XT**  
 Thanking you for the appreciation you have shown for Cellular Line products, Cellular Italia S.p.A. wishes to provide you with the useful information contained in this manual.  
 The InterphoneF5XT is a Bluetooth® device for helmets that can provide wireless communication among a number of users, thanks to Bluetooth® 3.0 technology.  
 With its quick-fasten/release bracket, InterphoneF5XT can be installed on most helmets, and the ergonomic shape of the control module makes it easy to operate the keys, even while wearing gloves.  
 The InterphoneF5XT module is covered with a special film that protects against the weather (Weather protection skin system) and enables the unit to withstand extreme outdoor conditions. The entire Interphone F Series is certified to offer an IP67 level of protection.

### Contents of the package

- Bluetooth® control panel
- Stereo earphone equipped with a microphone with foam windscreen, on a flexible arm (universal)
- Stereo earphone with wired microphone for full-face helmets
- Removable clip-on support
- Permanent adhesive-based support
- USB cable for recharging
- USB cable for updating
- Extendible cable for audio connections (2.5 mm/3.5 mm)
- Velcro adhesive strips
- Clip adapter
- Screwdriver
- Instruction manual

**NOTES:** in the package containing two F5XT kits, components a - b - c - d - e - h - i - j - k are doubled.

### Product description

InterphoneF5XT Bluetooth® module

- Multi-purpose button
- Menu UP button
- Menu DOWN button
- + Volume button
- Volume button
- Multifunction LED
- Multifunction LED
- Multifunction socket
- Bluetooth® module connection guide

Audio unit for open-face, modular and full-face helmets:

- Left earphone
- Right earphone
- Left/Right earphone connectors
- Microphone connectors (B or C)
- Microphone with foam windscreen
- Connection plug
- Recharge/aux in socket

### Care and maintenance

If not using the kit for long periods of time, the battery must be charged every two/three months, to avoid damage.

To clean, use a damp sponge and mild soap, if necessary. Do not use solvents or degreasing products to clean the module.

Important note: to prevent water from seeping in through the audio connector and damaging the module during cleaning, be sure to insert the plug from the audio section into the socket, as when the unit is installed and used on the helmet. The kit is watertight only when the audio plug is inserted.

**WARNINGS:** If radio interference is high due to the vicinity of repeaters, high voltage towers or various kinds of radio signals, intercom communication and/or the InterphoneF5XT device itself could shut down.

To restore operation, try moving away from the area of interference and/or turn the InterphoneF5XT off and then back on.

### Assistance and Warranty

This product is covered by a warranty that complies with the laws in the country where the unit was purchased.

All information necessary for product assistance or spare parts can be found on our website [www.interphone.cellularline.com](http://www.interphone.cellularline.com).

## 1.0 Preparation/assembly

**InterphoneF5XT is a modular audio kit made up of a Bluetooth® module (the core of the system) (A), a double slide support system for the module (E/D) and an audio kit with a double microphone to be installed inside the helmet (C/B). Before configuring the InterphoneF5XT, you should check the website for software updates that could improve the performance of the F5XT. If there are any updates, installation is recommended. Verify compatibility with the operating system on your PC, then download the file and the attached instructions that will guide you through the update process.**

### 1.1 Mounting the bracket on the helmet

The InterphoneF5XT has two mounting systems (small plates) (E/D) that you can install on the helmet. Choose the system that is better suited to the type of helmet you are using.

Equipped with a sliding latch system, the plates support and lock the F5XT Bluetooth® module into position. One system is applied using an adhesive system (E), and the other uses a clip (D).

Thanks to the sliding latch system on the plates, the F4XT module can easily be removed for recharging, updating, security against theft, and use on other helmets that have already been prepared with other kits designed for each type of helmet.

The kits for an additional helmet all consist of an audio section with earphones/microphone, along with two support plates for the module.

The kits for an additional helmet are optional and can have a different structure and operation. For more information, consult the accessory section on our website, [www.interphone.cellularline.com](http://www.interphone.cellularline.com)

**We recommend using the adhesive plate (E)** since it is more aerodynamic and can be placed wherever you like on the surface of the helmet. This allows you to choose the point that best suits the shape of the helmet shell to maximize appearance and adhesion.

On the other hand, the adhesive plate cannot be repositioned. Once it is applied, it cannot be removed because the 3M adhesive that provides its excellent holding power does

not allow for a change of position. If the plate is removed, it must be replaced with a new one. Carefully choose the most suitable point before application.

**The clip-on plate (D)** is better for those who do not want to apply permanent adhesive to their helmet or would like to be able to remove the plate and use the helmet with no accessories installed.

The clip-on plate requires that the helmet allow part of the plate to be inserted between helmet shell and cheekpad. The cheekpads on some helmets are glued or have special seals that prevent the plate from being inserted correctly or require the helmet to be modified, which not everyone is willing to do. In these cases, it's better to choose the adhesive plate.

Both brackets can only be installed on the left side of the helmet.

#### Installation with (adhesive) plate

Take the adhesive plate, but do not remove the protective film on the back. Place the plate on the left side of the helmet shell. Now, move it around and find the position where it will adhere and function best. Before applying it, mount the F5XT module on the plate and check whether the position you chose could disturb the driver by causing interference or discomfort (check visor, opening, etc...).

Carefully clean and degrease the point chosen for applying the plate. Do not use strong detergents that could ruin the paint on the helmet. After cleaning the helmet shell, remove the protective film from the double-sided adhesive strip and apply the plate on the helmet. Press quickly on the plate to attach the strip firmly.

After application, it is a good idea to let the 3M adhesive act on the helmet for 12 hours before using the helmet.

#### Installation with the clip-on (removable) plate

Check the type of helmet you have and make sure that the clip can be inserted between helmet shell and cheekpad. Otherwise, use the adhesive plate.

Take the clip-on plate, loosen the two screws and remove the rear section.

On the left side of the helmet, locate the most suitable point for inserting the clip, slide the rear section of the clip in between the helmet shell and the cheekpad, and let the

end (with the holes for the screws) protrude on the outside. Now, try to join the front section of the clip onto the rear section. Depending on the thickness/radius of the helmet, it may be necessary to use the adapter (J) to compensate for the distance between the two sections so that the clip still adheres to the helmet shell when the screws are tightened. Tighten the screws with the screwdriver provided. Do not use excessive force when tightening the screws. You could break all or part of the clip.

If you are also using the adapter for the clip, you must replace the two screws installed in the clip with the longer ones supplied with the unit.

### 1.2 Audio section (microphone/earphones) (C/B)

InterphoneF5XT with audio kit with two microphones, connected to the earphone with a mini jack to be able to choose the most suitable based on the type of helmet. This makes mounting easy and possible on open-face and modular as well as full-face helmets.

Open-face/modular helmets use the kit with the microphone mounted on a flexible metal arm (B), since the arm must remain suspended in front of the user's mouth. Full-face helmets use the audio kit with the microphone connected to the earphone by a thin wire (C) that can be handled and hidden easily during installation. The microphone is encapsulated in a strip of flexible rubber and is applied on the inside of the chin strap with adhesive or Velcro, in front of the user's mouth.

The right earphone is connected to the audio section with a moveable mini-jack. Use only the left earphone in countries where the use of a double earphone is prohibited.

#### Installing the audio section

Wear the helmet and locate the exact point where your ears are positioned inside.

If the internal fabric of the helmet allows it, try to apply the two earphones in the audio kit directly at the points you determined. The Velcro on the back of the earphone will often adhere perfectly to the material in the helmet without the need to use the fabric strip (I) with double-adhesive. Otherwise, if the material is unmanageable, apply the strip of fabric at the point you previously determined and place the earphone on the strip.

Put on the helmet once again and check whether the

earphones are correctly positioned. They must be centred and come slightly in contact with your ears.

If the helmet allows it, it's a good idea to insert the earphones under the cheekpad fabric, which requires more time and care to accomplish but makes the internal kit almost invisible and more comfortable.

Thread the cable with plug under the cheekpad and around the helmet while trying not to lay it over itself or twist it. Then, pull it out on the left side as far as it will go. Afterwards, when the plug is connected to the F5XT module mounted on the support, you can push the excess cable back inside and leave only as much as you need on the outside.

**Microphone on open-face/modular helmets (B)** - if possible, slide the microphone arm through the hole in the chin strap and below the cheekpad so that the microphone is more stable and less obtrusive. It should be possible to position the microphone with foam windscreen (14) in front of your mouth, but it may be left slightly to the side of the mouth.

After installation is complete, make sure that the wording MIC on the foam windscreen on the microphone arm faces your mouth and preferably points toward your eyes.

**Microphone on full-face helmets (C)** - the wire from the microphone must exit from under the cheekpad, and the microphone (14) must be installed on the inside of the chin guard and in front of the mouth.

Make sure that the microphone as installed does not block any ventilation holes, and check that the ventilation holes are not pointing directly at the microphone.

The microphone can be installed directly using the built-in double-sided tape (fixed mounting).

### 1.3 Recharging

The InterphoneF5XT must be charged before use.

Once mounted on the helmet, connect the recharger cable provided (F) to a USB port, then insert the recharger cable plug into the outlet on the audio kit connector (16) correctly inserted in the InterphoneF5XT module.

The charge LED turns orange (7) during charging.

When the battery is fully charged, the LED will turn green.

About two hours are needed to charge the F5XT module completely. Two modules can be charged together in around three hours.

We recommend turning the module off before recharging the F5XT.

## BASIC FUNCTIONS

**1.4 Connecting the F5XT module on the helmet**

After you install the mounting plate and the microphone/earphones audio kit: working from the top downwards, line up the two guides (9) with the holes in the support and latch the module (A) onto the support. Check that the F5XT module is correctly locked into position by trying to slide it upwards.

**1.5 Connecting the F5XT module with the audio kit**

Line up the guide on the plug (14/20) with the guide on the end of the plate and slide the plug from right to left until it is completely inserted.

Apply a fair amount of pressure to make sure the module is watertight.

**1.6 REMOVING THE BLUETOOTH® CONTROL PANEL FROM THE HELMET**

First, pull the plug out from the module, grasp the plug and slide it in the guide from left to right until it is completely removed. Do not pull on the cable gland or the cable itself to remove the plug.

To remove the Bluetooth® module, press the lock lever (M) gently toward the helmet shell, hold the lever down, and slide the Bluetooth® module upwards until it is completely removed.

**Attention: The F5XT module cannot be removed unless the connecting plug to the audio kit (14/20) has been pulled out. The audio plug also acts as a safety catch that prevents the module from accidentally pulling out or releasing while the helmet is worn.**

**1.7 Turning on the F5XT module**

Press and hold down the Multi Function Button (MFB) (1) for about 3 seconds, and release it when you hear a two-tone audio signal and the LED (6) lights up with a blue colour.

When the F5XT is turned on for the first time, it will automatically switch from standby to the function used for setting the language, which must be selected before proceeding.

After you select your language, the F5XT will switch to the pairing mode and wait for a device. To connect a Bluetooth® device, follow the steps at point 2.1 below. To exit the pairing mode and pair a device later on, shut off the F5XT.

**1.8 Turning off the F5XT module**

Press and hold down the Multi Function Button (MFB) (1) for about 5 seconds, and release it when you hear an audio tone and the LED (7) lights up with a red colour. The device will turn off in a few moments.

**1.9 Adjusting the listening volume**

The volume can be adjusted at any time using the + and - buttons (4/5) on the F5XT module. The latest-generation technology built into the F5XT allows the volume of the telephone, radio, intercom, music and wired auxiliary input to be adjusted independently.

This technology lets you personalize the volume to suit the audio source and prevents jumps in volume that could occur when you switch from one audio source to another.

To increase or decrease the volume, press the + or - button as many times as needed to set the desired volume. Do not hold the button down. At each press of the button, a sound will indicate the selected volume level.

**UP and DOWN buttons**

The UP and DOWN buttons (2/3) are used to move through the voice menus when searching for the required function. The UP and DOWN buttons also perform other supplementary functions, which are explained by the voice wizard.

When the F5XT is in standby, the voice wizard will say a function every time the UP or DOWN button is pressed. If you remain at a function for three seconds, the voice will tell you how to activate and use the function.

For example, if you stop on FM Radio, the voice wizard will say "press the centre button to activate the FM Radio" and once it has been pressed it will say "FM radio activated" then "current station", "press the UP or DOWN button for two seconds to seek stations", "press the centre button for two seconds to store the station", "press the UP or DOWN buttons to select the stored station", etc.

In essence, the voice wizard allows you to use the many functions on the F5XT easily, without the need to remember how and what button to press in order to do a certain thing. A complete list of the voice wizard messages can be found at point 3.5, below.

However, once the language has been set on the F5XT, it's easier and more practical to follow the voice wizard directly when using the device.

Expert users can reduce the number of voice wizard instructions in the SETUP menu.

**2.0 Pairing**

Interphone F5XT is a Bluetooth® device that is compatible with most equipment using the Bluetooth® wireless protocol.

To permit communication between the F5XT and one or more compatible devices, the pairing procedure must be performed at least once with each device. This procedure called "Affiliation or pairing" remains stored in the F5XT even after it is shut off.

The Interphone F5XT can store up to 8 different devices in memory and automatically erases the oldest pairings when extra devices are paired.

The pairing procedure can be repeated at any time and must be performed at least once, even with other F5XT units that will be used in the intercom mode.

A RESET can be performed to return the F5XT to its factory settings or remove pairings with devices.

**Erase pairings**

This procedure is used to erase all the pairings stored in the F5XT.

Press the UP or DOWN button to scroll through the voice menu, and stop at "Setup".

The voice wizard will ask you to press the central MFB button to enter the setup menu. Scroll through the setup menu by pressing the UP or DOWN button and stop at "Erase pairings". Next, press the central MFB button for two seconds to erase all the pairings.

The voice wizard will confirm the "pairings erased" operation, and the F5XT will automatically set itself to the pairing mode, as described in point 2.1.

**Reset**

The F5XT is returned to factory values when a reset is performed. This erases the stored radio stations and the devices associated with the unit.

Turn off the F5XT, press and hold down the UP and DOWN buttons and while holding them down press the central MFB button. Now, release all the three buttons.

The operation will be confirmed by the F5XT with a short melody and by the blue LED lighting up for around one second. The audio kit must be connected to the F5XT in order to hear the melody.

**2.1 Procedure for pairing with Bluetooth® devices**

With the F5XT shut off, press and hold down the Multi Function Button (MFB) for about 5 seconds and release it when the two red/blue LEDs (6/7) flash in alternating fashion.

Now, the F5XT will prompt you to press the MFB button to select the desired language. The request will automatically be made in all the available languages.

Before pressing the button, wait for the request in the language you wish to use. Confirm it as requested by pressing the MFB button.

After the language has been confirmed, the red/blue LEDs

will continue to flash in alternating fashion, which shows that the unit is in the pairing mode.

Select the Bluetooth® connections menu on the device you wish to pair (phone, Bluetooth® MP3 player, GPS Navigator, etc.) and search for a new device.

For further information on how to search for/pair a new audio device using Bluetooth®, see the instruction manual for the device you are using.

The device will detect the F5XT (with the name Interphone F5XT) and will be paired automatically.

If a password is requested, enter four zeros: "0000"

At this point, the F5XT will automatically switch to standby, and the LED will flash blue twice every three seconds to show that the unit is in standby and is connected to the device. If the connected device is switched off, the LED will flash only once every three seconds.

To pair a second device, repeat the above procedure: switch off the F5XT and repeat the instructions from the beginning, starting with activation of the F5XT in the pairing mode.

**Using a Bluetooth® device connected to the F5XT Mobile Phone**

If you have a mobile phone and it rings, wait a few rings and then answer by saying "hello" or something else. If you don't want to answer, the call will be dropped automatically after around 5 rings.

Attention: Noise from traffic, horns, mufflers, etc. could trigger the voice-activated answering system.

Voice-activated answering can be disabled if desired, but you must then answer calls by pressing the MFB button. If you don't press the MFB button, the phone will ring without stopping. To drop the call without answering, press the MFB button twice.

To place a call, press the MFB button once and wait for a signal from the mobile phone. The way this function is signalled depends on the phone you're using (for further information, see the instruction manual for the mobile phone).

Once you know how your phone signals that it's ready to receive a voice command, say the name you wish to contact. When using this function, it's a good idea to drive more slowly for safety reasons and to make the name easier to understand.

**GPS**

GPS Navigators for motorcycle use can send navigation messages and other information using the Bluetooth® protocol. Models in the mid-to-upper range have two Bluetooth® modules that can handle earphones and a mobile phone at the same time.

Except for the models listed above, navigators designed for cars are not compatible with the F5XT since they do not have a Bluetooth® audio output. These models only have an output for a Bluetooth® phone connection, which enables the phone book in the phone to be displayed and the GPS navigator to be used as a speakerphone for telephone calls. See the manual for your GPS navigator to find out which functions it supports.

If you have GPS installed in your Smartphone, you must make sure the software can send messages via Bluetooth®.

**Bluetooth® Music**

If you've paired a mobile phone or GPS unit that can handle MP3 files and send them using the A2DP Bluetooth® stereo profile, you can listen and manage music from the F5XT.

You can play/pause by pressing the MFB button for two seconds, forward/reverse through songs by pressing the UP or DOWN buttons, and adjust the volume by pressing the buttons repeatedly until the desired level is reached.

Music cannot be shared by two or more users. Each user can only listen to and control the music coming from his or her player.

If you don't have a phone, or if your phone does not have MP3/Bluetooth®, you can use an MP3 Bluetooth® player to send audio using the A2DP stereo profile.

NOTE: On phones equipped with a music player, and which therefore include a stereo profile (A2DP), both the phone and the stereo (A2DP) functions can be used, even though only one of these functions is usually utilized. In this case, it may not be possible to connect another stereo (A2DP) player, so you will have to use the MP3 player built into the mobile phone.

**Built-in FM Radio**

To activate the radio function on the F5XT, press the UP button repeatedly to scroll through the menus and stop when the voice wizard says, "**FM Radio**". Wait for the next phrase from the voice wizard and, as requested, press the MFB button to select the "FM Radio" mode.

Follow the instructions given by the voice wizard to search for new stations and to store them.

**Auxiliary/recharger input**

An auxiliary input is provided on the audio section plug (16) for combined use with an extension cable (H) so you can listen to external audio sources. The audio sources are connected to this cable through the headphone jack, which must accept a 3.5 mini jack plug.

To activate the auxiliary input, press the UP button repeatedly to scroll through the menus and stop when the voice wizard says, "**Auxiliary input**". Wait for the next phrase from the voice wizard and, as requested, press the MFB button to select the "**activate auxiliary input**" mode. Although the external source cannot be controlled by the module on the helmet, the volume can be regulated using the volume settings on the F5XT.

**2.2 Pairing two InterphoneF5XTs**

With the F5XT shut off, press and hold down the MFB button for about 5 seconds, and release it when the two red/blue LEDs flash in alternating fashion.

Next, the F5XT will ask you to press the MFB button to select the desired language.

The request will be made automatically in all available languages.

Before pressing the button, wait for the request in the language you wish to use. Confirm it as requested by pressing the MFB button.

If the F5XT has already been paired with another device, the first request will be in the previously selected language. Simply press the central MFB button to confirm.

After the language has been confirmed, the red/blue LEDs will continue to flash in alternating fashion, which shows that the unit is in the pairing mode.

Repeat the same pairing procedure on the second F5XT.

Now that both F5XT units are in the pairing mode, simply press the UP button on either F5XT to pair them. The LEDs will begin to flash much more quickly to show that it is searching for another kit.

After 10 seconds, pairing of the two devices will be complete, the red LEDs will shut off, and the blue LEDs on both kits will remain lit.

The steadily lit blue LED shows that intercom communication is enabled.

**Using two-way intercom communication**

Press the centre button for 1 second to activate intercom communication. The F5XT will say "**connecting intercom**". When the connection is established, the F5XT will say "**in-**

**tercom activated**". Full duplex communication is now available.

**Disconnecting the intercom:** If you wish to exit intercom mode, press the centre button of the F5XT for one second. The F5XT will say "**disconnecting intercom**" then "**intercom disconnected**" at this point you can select another type of function from the F5XT menu.

**2.3 Procedure for pairing three InterphoneF5XTs**

After pairing two modules as described in point 2.2, repeat the procedure using either of the two paired modules and the third module you wish to pair.

After the three modules have been paired, the following types of operation will be available:

**"Selective" three-way intercom communication**

(three users - ABC) - A paired with B and C:

with this configuration, A can choose to talk with B or with C.

The first rider (rider B) paired with A is stored on the UP button. To communicate with B, A must press and hold down the UP button (and release it when an audio alert is heard).

The second rider (rider C) paired with A is stored on the DOWN button. To communicate with C, A must press and hold down the DOWN button (and release it when an audio alert is heard).

**"Conference" three-way intercom communication**

Make sure that rider B is paired with riders A and C.

Press rider B's MFB button for approx. two seconds (and release it when the audio alert is heard). When the button is released, riders A and C will connect automatically.

Full duplex communication between all three users is now available.

**Disconnecting the intercom:** If you wish to exit intercom mode (riders A and C), press the centre button of the F5XT for one second. The voice wizard will say, "**disconnecting intercom**" and then "**Intercom disconnected**". You can now select another type of operation using the menu on the F5XT.

If your F5XT module is connected to two other users (rider B), you can exit the intercom mode by pressing the MFB button for two seconds and releasing it when you hear the audio alert. A short press will disconnect only one user, and a long press will disconnect both.

**If you exit the intercom mode during three-way conferencing, press the MFB button again to restore the connection.**

**Since the modules are not paired with each other in the same way, if pressing the button does not restore the previous operation, try pressing it for a few seconds and then releasing it when you hear the audio alert.**

**If you can't re-establish the connection after this attempt, set all the F5XTs to standby and activate communication by pressing rider B's button for two seconds.**

**2.4 Procedure for "Conference" pairing of four InterphoneF5XTs**

Make sure that rider A is paired with rider B and that rider C is paired with rider D, as described at point 2.2 above. Now, use the same procedure to pair rider B with rider C.

**Using four-way intercom "Conference" communication** (four users: A-B-C-D)

Press and hold down rider B's centre button (and release it when an audio alert is heard). Riders A, B and C will now connect automatically.

Full duplex communication between three users is now available. To include the fourth user, press rider D's centre button briefly, which will activate full duplex communication between all four users.

**Disconnecting the intercom:** If you wish to exit intercom mode, press the centre button of the F5XT for one second. The F5XT will say "**disconnecting intercom**" then "**intercom disconnected**" at this point you can select another type of function from the F5XT menu.

**If you exit the intercom mode during four-way conferencing, press the centre button again to restore the connection.**

**Since the modules are not paired with each other in the same way (some modules control others), if pressing the button does not restore previous operation, try holding it down for a few seconds and then releasing it when you hear the audio alert.**

**If you can't re-establish the connection after this attempt, set all the F5XTs to standby and repeat the initial operations described above. Activate communication by holding down rider B's button for two seconds and then pressing rider D's button briefly.**

### 3.0 Notes and General Recommendations

#### 3.1 Device shutdown

If radio interference is high due to the vicinity of repeaters, high voltage towers or various kinds of radio signals: the radio/Bluetooth® communication and/or the devices themselves could shut down.

To restore operation, try moving away from the area of interference and/or turn the devices off and then back on.

Do not disassemble or attempt to repair the kit for any reason. If an unauthorized person opens the F5XT module, the warranty will automatically be voided.

#### 3.2 Range

##### TWO MOTORCYCLES - UP TO 1,300 m



##### THREE MOTORCYCLES - UP TO 1,600 m



##### FOUR MOTORCYCLES - UP TO 1,800 m



#### 3.3 Electromagnetic compatibility

All electronic equipment is subject to electromagnetic interference (EMI) if not adequately shielded and designed or configured for electromagnetic compatibility.

To avoid electromagnetic interference and/or compatibility problems, turn your F5XT units off wherever warning signs ask you to do so; for instance, in hospitals and/or health care facilities and areas at risk.

#### 3.4 Operating precautions

Do not open, replace, or remove the internal battery pack. Replacing the internal battery may only be done at an authorised service centre. Consult the website, [www.interphone.cellularline.com](http://www.interphone.cellularline.com) or contact your dealer for details.

Be especially careful of how you handle the F5XT module when it is not being used. If you put it in your pocket, purse

or other container, it must not come into contact with metal objects that could enter the connector and cause short-circuits and/or break the connector.

The use of parts different from those recommended by the distributor can affect the device's certification: use only original spare parts.

Waste generated by electronic products must not be disposed of with ordinary household rubbish. This type of waste must be taken to the local recycling centre for safe disposal.

#### Potentially explosive atmospheres

Turn off your F5XT in areas with potentially explosive atmospheres. To prevent interference with detonation operations, turn off the device in the vicinity of radio control units controlling detonations or in any area with signs indicating, "Switch your radio off". Obey all safety signs, signals and instructions.

NOTE: Potentially explosive areas are usually (but not always) clearly marked. These areas include roadsides service stations, below deck on boats, fuel or chemical storage facilities and pipes, areas where the air contains particles or chemical compounds such as cereal powder, fine dust or metal dust, and all other areas where you are asked to shut off the engine in your vehicle.

#### Precautions

Do not expose the kit to rain or snow during charging. Do not use the battery charger if it has suffered a strong impact or if it has fallen or been damaged in any way.

Do not disassemble the battery charger. If it is reassembled incorrectly, there is a risk of electrical shock or fire.

Never modify the power cable supplied with the battery charger. If the plug does not fit the socket, use an approved adapter or install the right socket. To reduce the risk of damaging the power cable or socket, grasp the power supply and not the cable when disconnecting the battery charger from the socket.

To reduce the risk of electrical shock, disconnect the battery charger from the socket before attempting maintenance or cleaning. The use of non-original accessories can lead to the risk of fire, electrical shock or injuries.

#### 3.5 Voice wizard phrases

See page 8

WE RECOMMEND CHECKING FOR  
UPDATES ON THE WEBSITE

[WWW.INTERPHONE.CELLULARLINE.COM](http://WWW.INTERPHONE.CELLULARLINE.COM)



(Applicable in those countries of the European Union with recycling systems)

The symbol shown on this product or on its documents indicates that the product must not be disposed of with other domestic refuse at the end of its life cycle. To avoid damage to the environment or to health caused by the inappropriate disposal of refuse, the user is requested to separate this product from other refuse and to recycle it responsibly to favour the sustainable re-use of material resources.

Domestic users are invited to contact the sales point where the product was purchased or the local office with information regarding recycling of this type of product.

Business users are invited to contact their suppliers and to check terms and conditions of purchase. This product must not be disposed of together with other commercial refuse.

CE 0560

This product bears the CE mark in conformity with the regulations of the R & TTE Directive (99/5/EC). Cellular Italia S.p.A. hereby declares that this product conforms to essential standards and other norms under Directive 1999/5/EC. The user is forbidden from making variations or modifications of any kind to the device. Any variations or modifications not expressly approved by Cellular Italia S.p.A. will cancel the user's authorisation for the use of the device. The Bluetooth® trademark is the property of Bluetooth® SIG, Inc. For further information please consult <http://www.cellularline.com>

This product has an embedded, non-replaceable battery, do not attempt to open the product or remove the battery as this may cause injury and damage the product. Please contact the local recycling facility for removal of the battery. The embedded, non-replaceable battery is designed to last the life time of the product.

equipment off and on, the user is encouraged to try to correct the interference by one or more of the following measures:

- Reorient or relocate the receiving antenna.
- Increase the separation between the equipment and receiver.
- Connect the equipment into an outlet on a circuit different from that to which the receiver is connected.
- Consult the dealer or an experienced radio/TV technician for help.

#### Operation is subject to the following two conditions:

- 1) this device may not cause interference and
- 2) this device must accept any interference, including interference that may cause undesired operation of the device.

#### FCC/IC RF Radiation Exposure Statement:

This equipment complies with FCC/IC radiation exposure limits set forth for an uncontrolled environment. End users must follow the specific operating instructions for satisfying RF exposure compliance. This transmitter must not be co-located or operating in conjunction with any other antenna or transmitter.

## NOTE

For excellent waterproofing, apply a thin layer of silicone on the parts highlighted in the image below.



CE 0560

Made in Philippines  
Model: BTMOTOF5XT  
FCC ID: QVNBTMOTOF5XT  
IC: 7717A-BTMOTOF5XT

INTERPHONE, complies with CEI EN 60529/1997  
The Bluetooth® word mark and logos  
are registered trademarks owned  
by Bluetooth SIG, Inc. and any use of  
such marks is under license.

COMPANY WITH QUALITY MANAGEMENT  
SYSTEM CERTIFIED BY DNV  
= ISO 9001:2008 =

**CELLULAR ITALIA** S.P.A.

Distribuito da: / Distributed by: CELLULAR ITALIA S.p.A.

via Lambrakis 1/A - 42122 Reggio Emilia - Italy  
tel. +39 0522 334002 - fax Italia +39 0522 1860810  
info.interphone@cellularline.com - international.interphone@cellularline.com

[www.cellularline.com](http://www.cellularline.com)  
[www.interphone.cellularline.com](http://www.interphone.cellularline.com)