

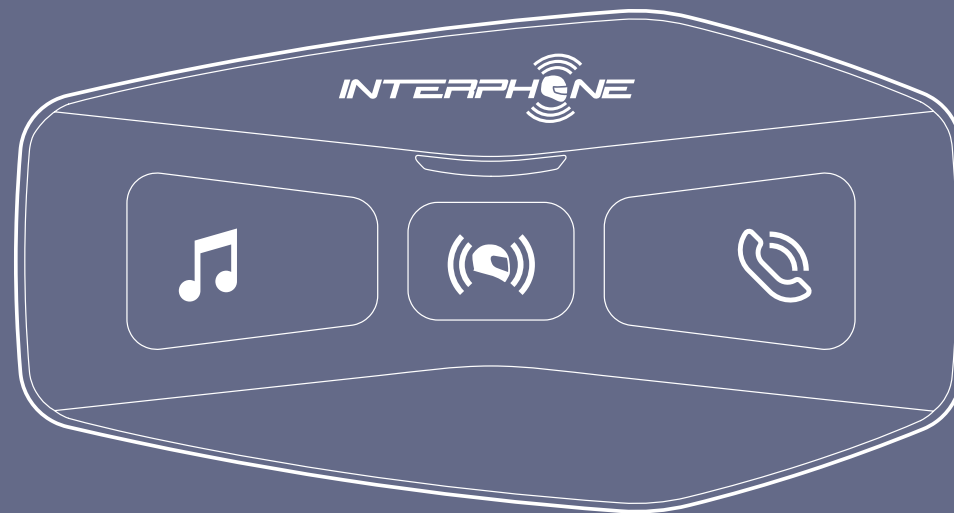

U-COM 2

User manual



SUMMARY

1. ABOUT **4**

1.1 Product details.....4

1.2 Package contents4

2. HOW TO INSTALL **5**

2.1 Install main unit 5

3. GETTING STARTED **6**

4. PAIRING WITH OTHER BLUETOOTH® DEVICES **6**

4.1 Pairing with Mobile phone / TFT systems 6

4.2 Second mobile phone pairing 7

4.3 GPS Pairing 7

4.4 Advanced Selective Pairing: Hands-Free or A2DP Stereo 8

4.4.1 Phone Selective Pairing - Hands-Free Profile 8

4.4.2 Media Selective Pairing - A2DP Profile 8

5. MOBILE PHONE USAGE **8**

5.1 Making and Answering Calls 8

5.2 Siri and Google Assistant..... 8

5.3 Speed Dialing 8

5.3.1 Using preset speed dial numbers..... 8

6. MUSIC **9**

6.1 Playing Music with Bluetooth® Devices 9

6.2 Condivisione della musica 9

7. BLUETOOTH® INTERCOM **10**

7.1 Intercom pairing 10

7.2 Two-way Intercom Conversation 11

7.3 Three-Way Conference Phone Call with Intercom Users
(with “Advanced Features” activated by APP or Device Manager)..... 11

7.6 Old Interphone Series12

7.7 Anycom12

8. FM RADIO **13**

8.1 FM Radio features.....13

8.2. Radio Stations memory13

8.3 Region Selection13

8.4 Storing temporary stations
(with “Advanced Features” activated by APP or Device Manager).....13

9. FUNCTION PRIORITY AND FIRMWARE UPGRADES **14**

9.1 Function Priority14

9.2 Firmware Upgrades14

10. CONFIGURATION SETTING **14**

10.1 Headset Configuration Setting14

10.1.1 Delete all pairings14

10.2 Device settings.....15

10.2.1 Speed dial15

10.2.2 Unit Language.....15

10.2.3 Audio Equalizer (Default: Off).....15

10.2.4 VOX Phone (Default: Enable).....15

10.2.5 VOX Intercom (Default: Disable).....15

10.2.6 VOX Sensitivity (Default: 3)15

10.2.7 Bluetooth® Intercom Audio Multitasking (Default: Disabled)15

10.2.8 Intercom-Audio Overlay Sensitivity (Default: 3).....	16
10.2.9 Audio Overlay Volume Management (Default: Disable)	16
10.2.10 HD Intercom (Default: Enable)	16
10.2.11 HD Voice (Default: Enable).....	16
10.2.12 Smart Volume Control (Default: Disable)	16
10.2.13 Sidetone (Default: Disable)	16
10.2.14 Voice Prompt (Default: Enable)	16
10.2.15 RDS AF Setting (Default: Disable)	16
10.2.16 FM Station Guide (Default: Enable).....	16
10.2.17 Advanced Noise Control™ (Default: Enable).....	16

11. TROUBLESHOOTING **17**

11.1 Fault reset	17
11.2 Factory reset.....	17

1. ABOUT

1.1 Product details

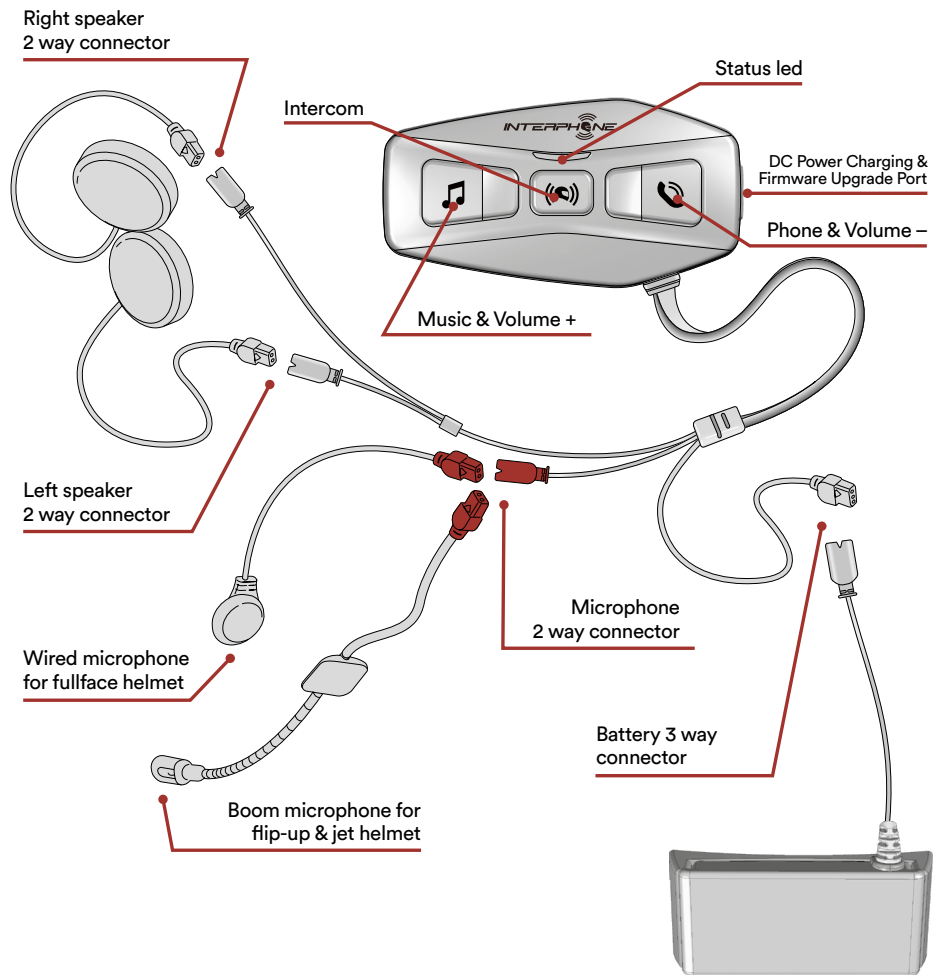

1.2 Package contents

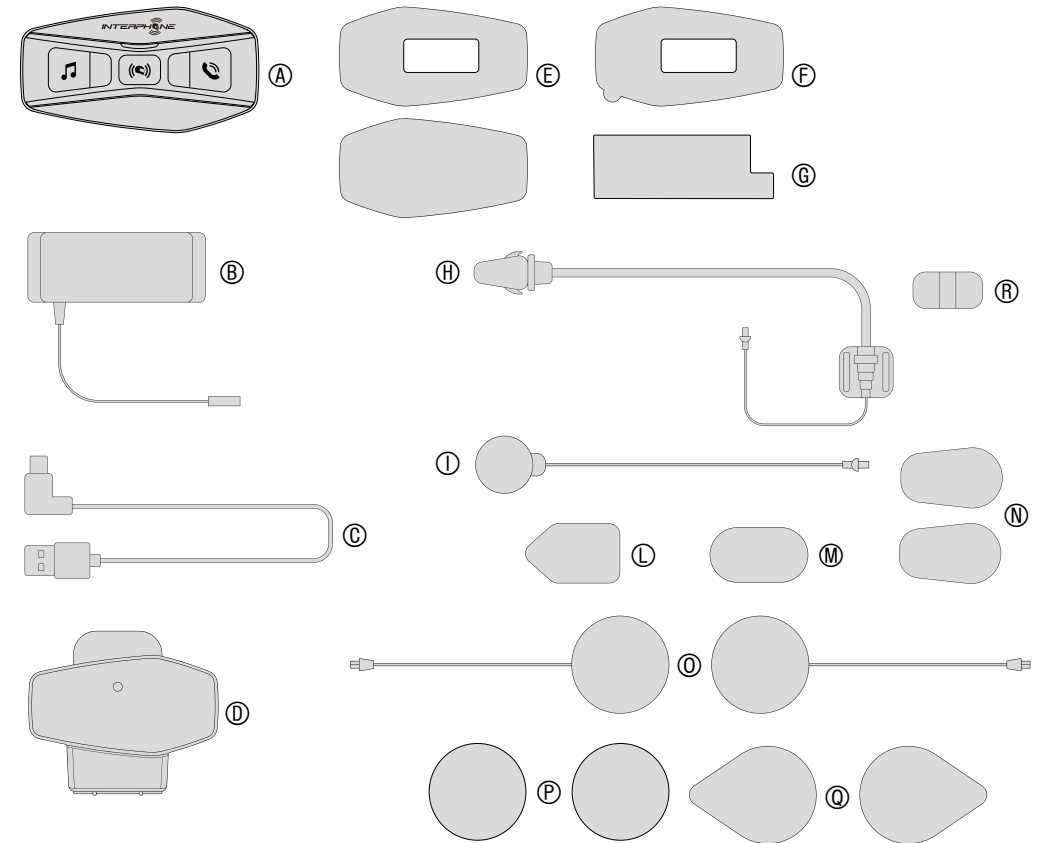

- A) Main unit
- B) Battery with bracket
- C) Data/charge cable usb type C
- D) Main unit bracket
- E) Main unit Velcro
- F) Main unit adhesive
- G) Battery bracket adhesive
- H) Boom microphone
- I) Wired microphone
- L) Boom microphone Velcro
- M) Wired microphone Velcro a
- N) Boom microphone foam cover
- O) Speakers
- P) Spacers for speakers
- Q) Speakers Velcro
- R) Boom microphone holder

2. HOW TO INSTALL

2.1 Install main unit

Using the hook and loop fasteners for main unit

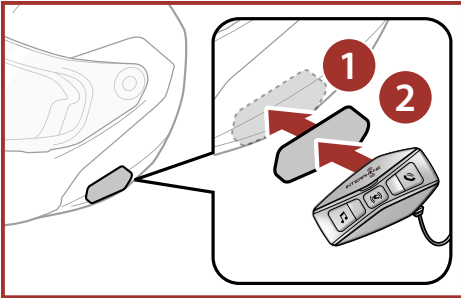

Using the double sided adhesive tapes for main unit

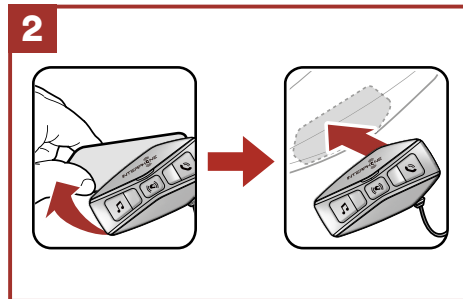
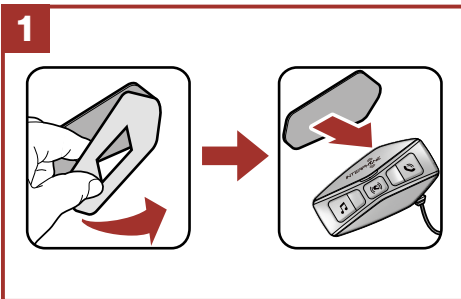

Using the clamp for main unit

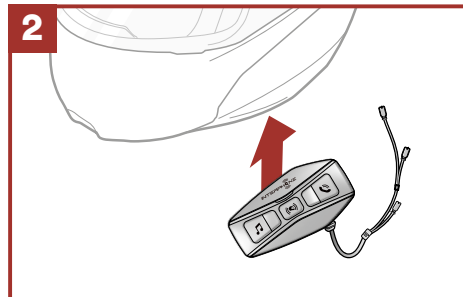
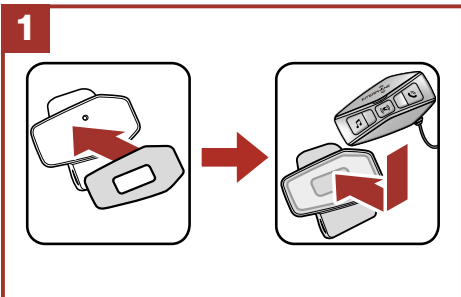

Installing the speakers and the microphone

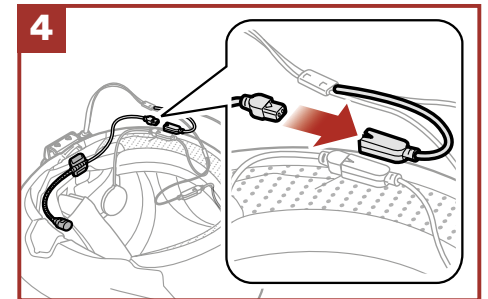
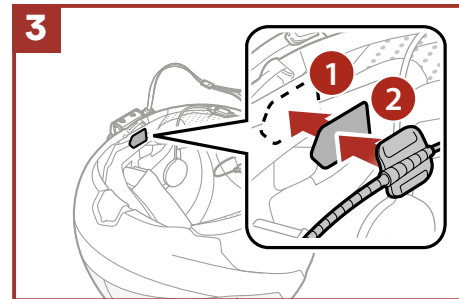
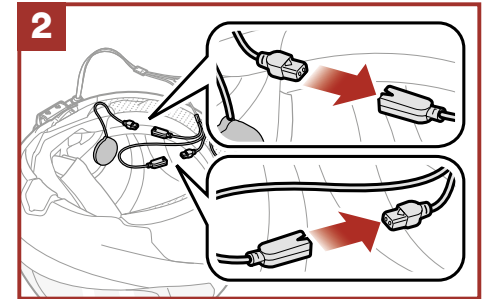
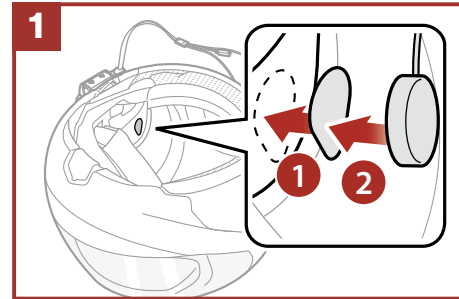

3. GETTING STARTED

Press once	Press twice	Press three times	Press and hold for 1 sec	Press and hold for 5 sec	Press and hold for 10 sec
-------------------	--------------------	--------------------------	---------------------------------	---------------------------------	----------------------------------

Power on	Power off
-----------------	------------------

Volume increase	Volume decrease
------------------------	------------------------

Charging

Note:

- U-COM 2 use a fast charging technology, via USB-C connector. Charging for 30 minutes will give 6h of intercom talking.
- Any USB charger with FCC, CE, IC or any local approval can be used.
- U-COM 2 is compatible only with USB device with 5V DC input.

4. PAIRING WITH OTHER BLUETOOTH® DEVICES

When using the headset with other Bluetooth® devices for the first time, they will need to be “paired.” This enables them to recognize and communicate with one another whenever they are within range.

U-COM 2 can be paired to another one U-COM units.

U-COM 2 can be paired to Bluetooth® devices such as mobile phones, GPS Satnav and TFT motorcycle multimedia systems.

4.1 Pairing with Mobile phone / TFT systems

1. Switch on Bluetooth® service on your phone (check device manual for more details).
2. With U-COM 2 on, press and hold central button for 10 seconds, to enter settings menu. Don't release the button until the led light is blue.
3. Press once MUSIC button to start phone pairing mode.
4. On your phone search for new Bluetooth® devices.
5. In few moments the phone will list “ U-COM 2 vx.x” among available devices to pair. Select this item.
6. If prompted for a PIN or code, enter 0000 (four times zero).
7. U-COM Voice guide will confirm the successful pairing.
8. If your smartphone asks for additional authorization please confirm.

Main phone pairing (to be done with unit on)			
---	--	--	--

Multimedia TFT system of motorcycle must be paired with “PHONE PAIRING”:

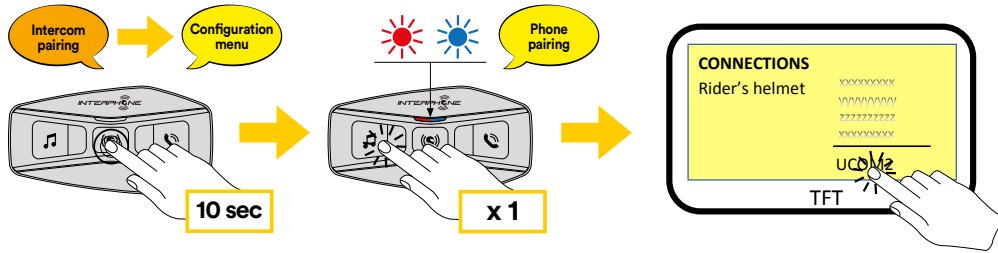

Note: There is an alternative way, to pair only the first phone (main telephone). With the control unit off, press and hold at the same time the MUSIC key together with the CENTRAL key, until the red / blue LED flashes.

The primary phone will have priority over the second phone, in case of simultaneous call reception on both phones.

4.2 Second mobile phone pairing

1. Switch on Bluetooth® service on your phone (check device manual for more details).
2. With U-COM 2 on, press and hold central button for 10 seconds, to enter settings menu. Don't release the button until the led light is blue.
3. Press the MUSIC button twice to activate Second mobile phone pairing mode.
4. Start the search for new Bluetooth® devices on the mobile phone.
5. In few moments the phone will list “U-COM 2 vx.x” among available devices to pair. Select this item.
6. If prompted for a PIN or code, enter 0000 (four times zero).
7. UCOM Voice guide will confirm the successful pairing.
8. If your smartphone asks for additional authorization please confirm.

4.3 GPS Pairing

1. Switch on Bluetooth® service on your GPS (check device manual for more details).
2. With U-COM 2 on, press and hold central button for 10 seconds, to enter settings menu. Don't release the button until the led light is blue.
3. Press the MUSIC button 5 times to activate GPS pairing mode.
4. Start the search for new Bluetooth® devices on the GPS.
5. In few moments the device will list “U-COM 2 vx.x” among available devices to pair. Select this item.
6. If prompted for a PIN or code, enter 0000 (four times zero).
7. UCOM Voice guide will confirm the successful pairing.
8. If your device asks for additional authorization please confirm.

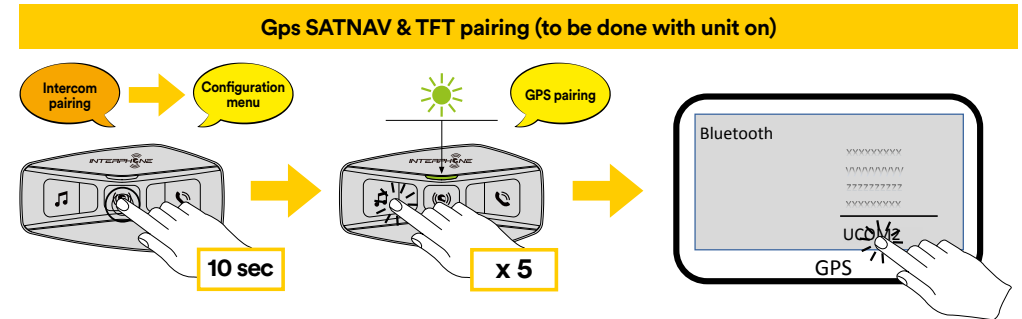

4.4 Advanced Selective Pairing: Hands-Free or A2DP Stereo

Phone Pairing allows the headset to establish two Bluetooth® profiles: Hands-Free or A2DP Stereo. Advanced Selective Pairing allows the headset to separate the profiles to enable connection with two devices.

4.4.1 Phone Selective Pairing - Hands-Free Profile

Execute Phone Selective Pairing in the Configuration Menu.

4.4.2 Media Selective Pairing - A2DP Profile

Execute Media Selective Pairing in the Configuration Menu.

5. MOBILE PHONE USAGE

5.1 Making and Answering Calls

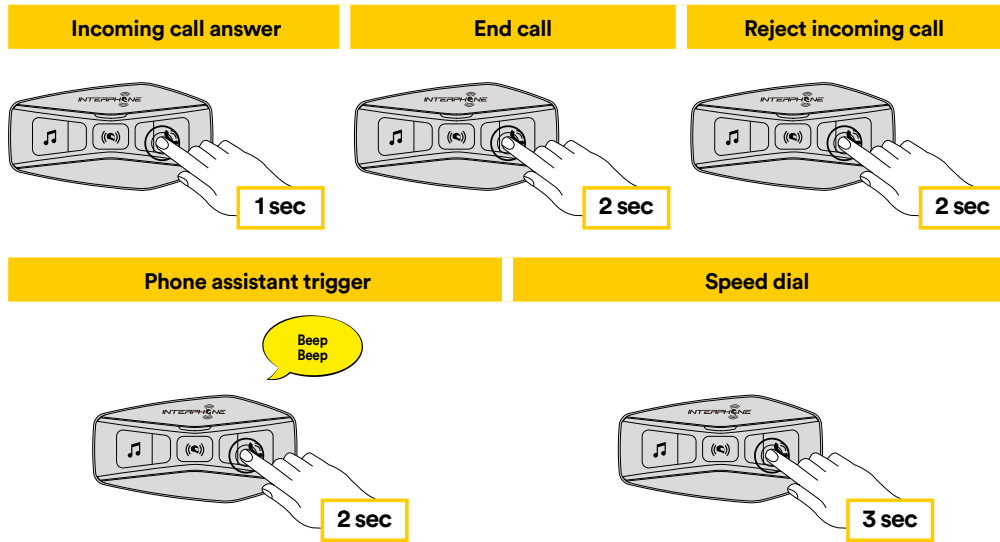

Note: If you have a GPS device connected, you will not hear its voice navigations during a phone call.

5.2 Siri and Google Assistant

U-COM 2 supports the Siri and Google Assistant access directly. You can activate the Siri or Google Assistant using the voice through the headset's microphone, a wake word will be used. This is a word or groups of words such as "Hey Siri" or "Hey Google".

5.3 Speed Dialing

It is possible to store up to 3 telephone numbers (if "advanced mode" is active) to be used as speed dials. You can set the speed dial numbers via UNITE APP or INTERPHONE Device Manager.

5.3.1 Using preset speed dial numbers

How to activate speed dial (with ADVANCED FEATURES off)

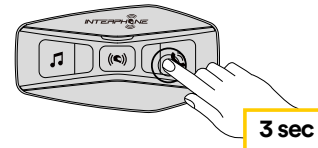

How to activate speed dial (with ADVANCED FEATURES on)

1. Enter into the Speed Dial menu.

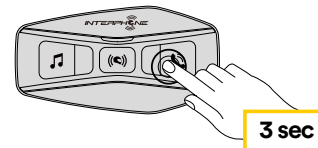

2. Navigate between the Speed Dial Preset with MUSIC and PHONE buttons, as indicated in picture here below. Select the wanted feature with CENTRAL button.

Select one function	Confirm selected function					
<table border="1"> <tr><td>Last number redial</td></tr> <tr><td>Speed dial #1</td></tr> <tr><td>Speed dial #2</td></tr> <tr><td>Speed dial #3</td></tr> <tr><td>Cancel (exit from menu)</td></tr> </table>	Last number redial	Speed dial #1	Speed dial #2	Speed dial #3	Cancel (exit from menu)	
Last number redial						
Speed dial #1						
Speed dial #2						
Speed dial #3						
Cancel (exit from menu)						

6. MUSIC

6.1 Playing Music with Bluetooth® Devices

Interphone U-COM 2 can play music from Bluetooth® devices (smartphones, MP3 players, Motorcycle TFTs etc ...) equipped with the A2DP profile. To play music you need to pair these devices to INTERPHONE U-COM 2.

Music play	Music pause	Next track	Previous track

6.2 Condivisione della musica

You can start sharing the music received from your phone with another U-COM control unit, during a two-way intercom conversation.

Both control units can control the playback of music, eg example go to the next track or the previous track.

Note: music sharing cannot be activated at the same time as an intercom conversation.

To start / stop sharing music, activate first the intercom conversation, then press the PHONE button for 3 seconds.

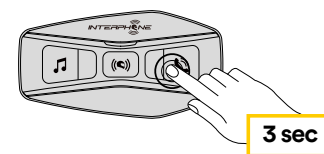

7. BLUETOOTH® INTERCOM

7.1 Intercom pairing

U-COM 2 can be paired with up to 3 other UCOM units (or Sena units), as shown in the following picture.

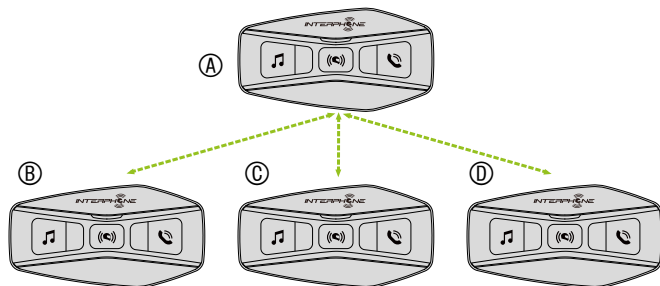

The pairing is only necessary the first time, then the control units will automatically recognize each other.

1. Press and hold the center button (intercom) on both units A and B for 5 seconds, until you hear the voice prompt “intercom pairing”. The light flashing red indicates the device is now visible.

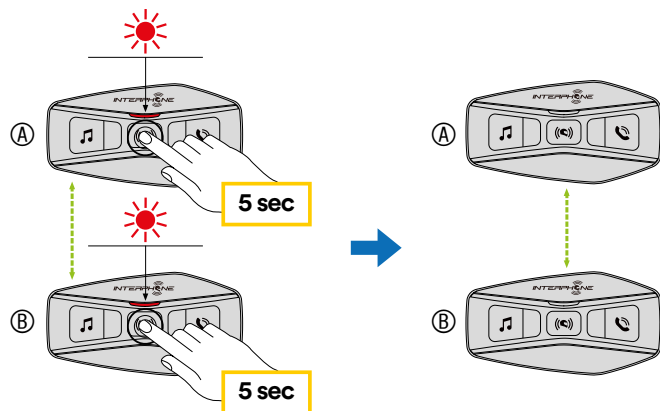

After few seconds the units will be paired and they will start the intercom communication. The light on both units will flash blue twice.

2. Repeat the previous step again, pressing the center button (intercom) on the two units A and C for 5 seconds until you hear the voice prompt “Intercom pairing”.

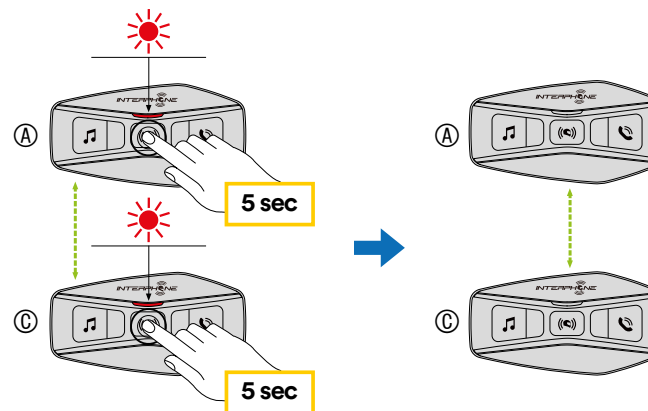

3. Repeat the procedure again, pressing the centre button (intercom) of the two units A and D for 5 seconds until you hear the voice prompt “Intercom pairing”.

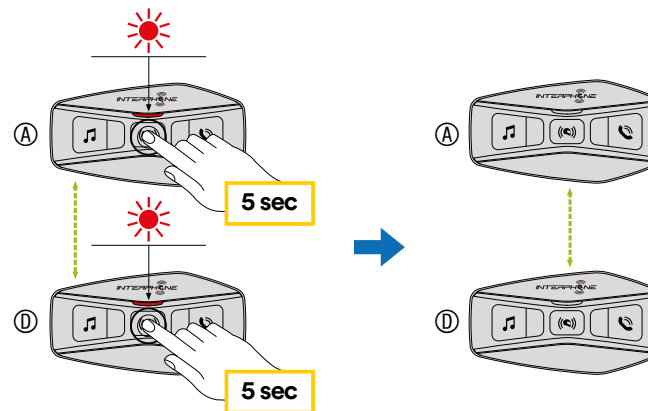

7.2 Two-way Intercom Conversation

After pairing the control units, communication can be started, by pressing the INTERCOM button (center button), according to the diagram below.

1. Press once to connect the control unit D.

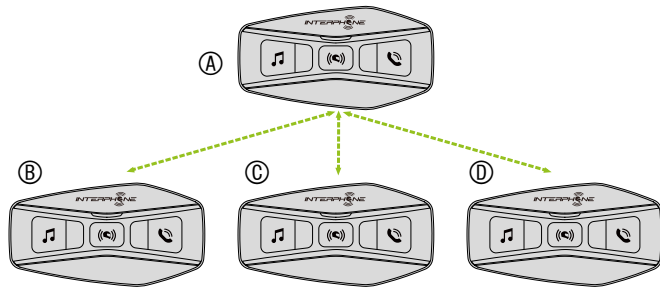

Start/stop intercom connection with unit "D"

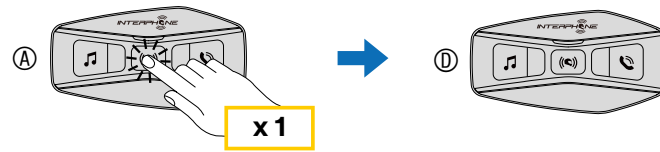

2. Press twice to connect the control unit C.

Start/stop intercom connection with unit "C"

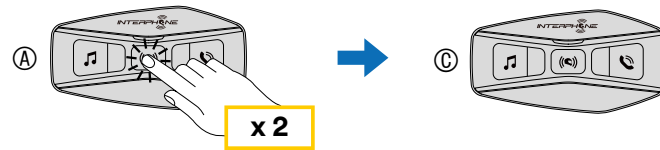

3. Press three times to connect the control unit B.

Start/stop intercom connection with unit "B"

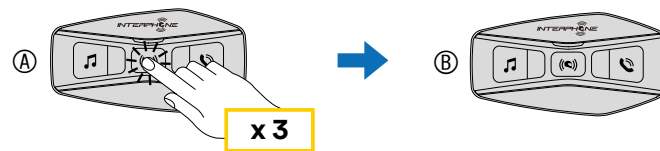

7.3 Three-Way Conference Phone Call with Intercom Users (with "Advanced Features" activated by APP or Device Manager)

You can have a three-way Conference-Phone Call by adding an intercom user to the mobile phone conversation.

During a mobile phone call, tap the center button once, twice or three times, to invite one of the intercom units (previously paired) to the conversation.

Press once to add unit D to the conference.

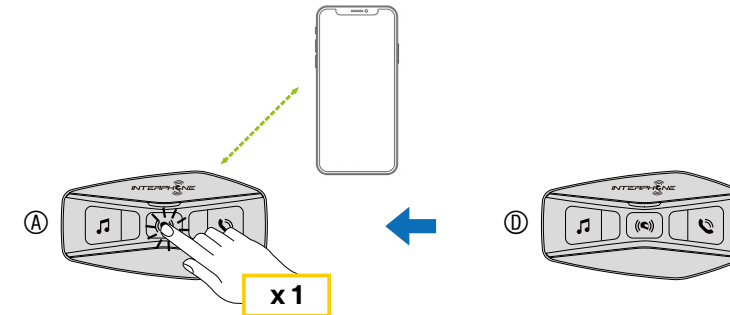

Press twice to add unit C to the conference.

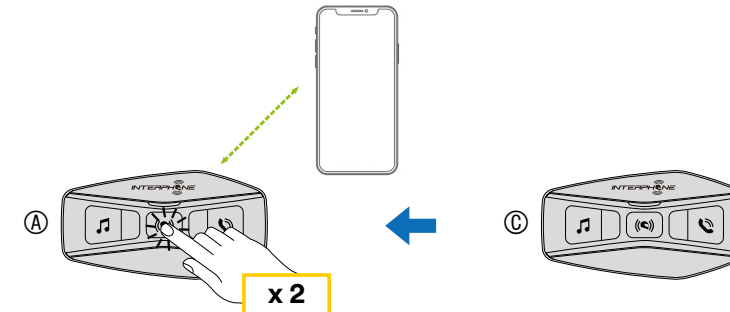

Press three times to add unit B to the conference.

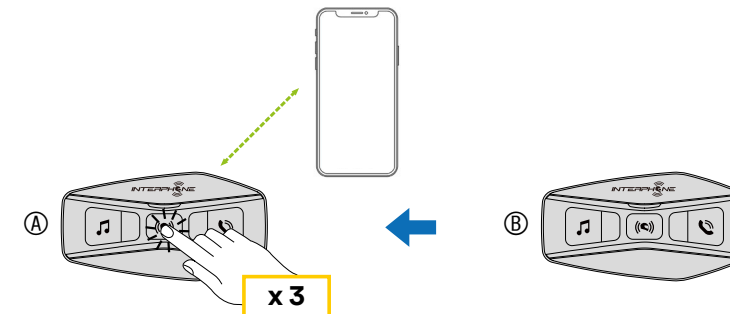

Repeat the same command to disconnect intercom unit from the phonecall conference.

To disconnect the mobile phone call during a conference phone call, press and hold the Center Button for 2 seconds.

Note: When you have an incoming intercom call during a mobile phone call, you will hear high tone double beeps.

7.6 Old Interphone Series

It is possible to pair previous Interphone series devices by pressing, with the unit on, the INTERCOM and TELEPHONE buttons for 5 seconds. Then start pairing mode on the second unit, usually pressing the power button (with the control unit off) until the led flashes red/blue.

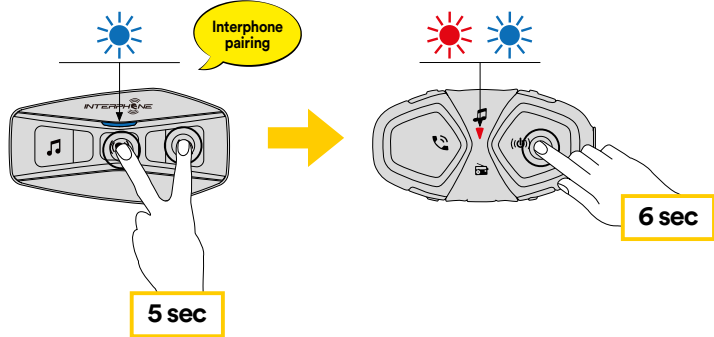

7.7 Anycom

Anycom feature allows intercom conversations with other intercom brands. It is possible to pair the intercom with only one non-Interphone device at a time. The intercom distance depends on the performance of the connected Bluetooth® intercom. When a not-Interphone device is paired with the Interphone device, if another Bluetooth® device is paired via the second mobile phone pairing, it will be disconnected.

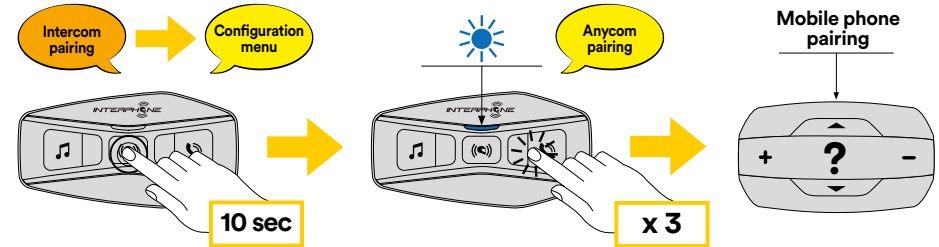

1. With U-COM 2 on, enter the configuration menu by pressing the central button for 10 seconds. Do not to release the button before the led turns blue.
2. Press the PHONE button 3 times to activate the ANYCOM pairing mode.
3. Set the not-Interphone intercom to mode Phone pairing.

8. FM RADIO

8.1 FM Radio features

Press MUSIC button for 3 seconds to switch ON/OFF the FM RADIO.

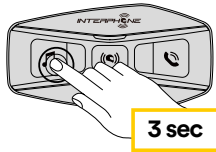

1. To start searching for radio stations, press the music key or the phone key for one second.

Next station



Previous station

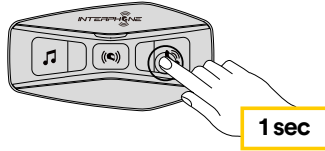

8.2. Radio Stations memory

Tune on station you want to save into memories. Press for three seconds the central button to start saving procedure.

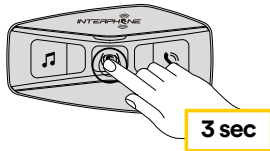

Navigate through the preset numbers that you want to store.

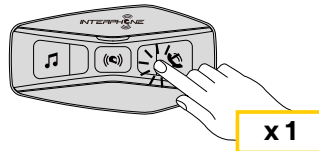
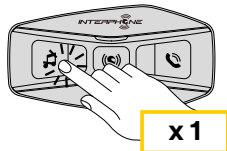

Press MUSIC button for one second to save station.

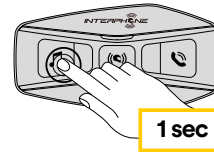

Any existing station will be overwritten.

Up to 10 stations can be stored on U-COM 2. You can navigate through the saved stations by pressing the central button for one second, advancing one memory at a time.

1 -> 2 -> 3 -> 4 -> 5 -> 6 -> 7 -> 8 -> 9 -> 10 -> 1 -> 2 -> 3 -> ...

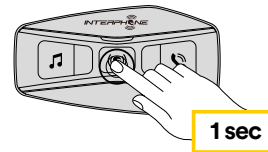

8.3 Region Selection

You can select the proper FM frequency range for your location from the Device Manager (available for PC and MAC on www.interphone.com) or the INTERPHONE UNITE App. Using the region setting, you can optimize the seek function to avoid unnecessary frequency ranges.

SETTINGS:

Worldwide 76.0 ~ 108.0MHz ± 100kHz

North America, South America and Australia 87.5 ~ 107.9MHz ± 200kHz

Asia and Europe 87.5 ~ 108.0MHz ± 100kHz

Japan 76.0 ~ 95.0MHz ± 100kHz

8.4 Storing temporary stations (with “Advanced Features” activated by APP or Device Manager)

The TEMPORARY STORE feature automatically searches and saves the 10 nearest radio stations, without changing the preset stations existing.

To activate the function, press the MUSIC button 3 times quickly. The temporary preset stations are canceled when the intercom is restarted.

9. FUNCTION PRIORITY AND FIRMWARE UPGRADES

9.1 Function Priority

The headset prioritizes connected devices in the following order:

1. (Highest) Mobile phone
2. Voice command mode
3. Bluetooth® Intercom
4. Music sharing via Bluetooth® stereo
5. FM radio
6. Bluetooth® stereo music

A lower-priority function gets interrupted by a higher-priority function. For example, stereo music will be interrupted by an Intercom Conversation; an Intercom Conversation will be interrupted by an incoming mobile phone call.

9.2 Firmware Upgrades

The headset supports firmware upgrades. Using the Device Manager utility (available for PC and MAC on www.interphone.com) you can upgrade firmware.

The USB Power & Data Cable (USB-C) must be connected to your computer, then start Device Manager on computer and follow instructions step by step.

Interphone Unite APP can check the firmware version present on the headset and inform you in case of a newer available firmware, but APP can't flash the new firmware to headset.

10. CONFIGURATION SETTING

10.1 Headset Configuration Setting

With U-COM 2 on, press and hold central button for 10 seconds, to enter settings menu. Don't release the button until the led light is blue.

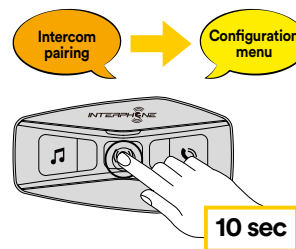

To navigate through the settings, press once the MUSIC button or the PHONE button.

1. Phone pairing
2. Second Mobile Phone Pairing
3. Phone selective pairing (pair a device with HFP profile only)
4. Media selective pairing (pair a device with the A2DP profile only)
5. GPS pairing

To confirm the following configuration menu options, press the CENTER button once.

6. Delete all pairings
7. Anycom pairing
8. Factory reset
9. Exit

10.1.1 Delete all pairings

Delete all Bluetooth® pairings stored in the device.

10.2 Device settings

You can change the device settings from the Device Manager utility (available for PC and MAC on www.interphone.com) or from the Interphone UNITE app.

Attention: the setting “Advanced Features” will enable the following headset features:

- Phone multiple speed dial
- Conference intercom + phonecall
- Smart FM station seek

10.2.1 Speed dial

Assign phone numbers for speed dialing to make a phone call quickly.

10.2.2 Unit Language

You can select the device language. The selected language is maintained even when the headset is rebooted

10.2.3 Audio Equalizer (Default: Off)

You can use the Audio Equalizer to increase/decrease the decibel level of different frequency ranges of audio.

- Balance will adjust all of the frequency ranges to be the same volume level (0 dB).
- Bass Boost will increase the bass range of audio (20 Hz - 250 Hz).
- Mid Boost will increase the mid range of audio (250 Hz - 4 kHz).
- Treble Boost will increase the high range of audio (4 kHz - 20 kHz).

10.2.4 VOX Phone (Default: Enable)

If this feature is enabled, you can answer incoming calls by voice. When you hear a ringtone for an incoming call, you can answer the phone by saying a word such as “Hello” loudly or by blowing air into the microphone. VOX phone is temporarily disabled if you are connected to intercom. If this feature is disabled, you have to tap the Center Button to answer an incoming call.

10.2.5 VOX Intercom (Default: Disable)

If VOX Intercom is enabled, you can initiate an intercom conversation with the last connected intercom by voice. When you want to start intercom, say a word such as “Hello” loudly or blow air into the microphone. If you start an intercom conversation by voice, the intercom terminates automatically when you and your intercom friend remain silent for 20 seconds. However, if you manually start an intercom conversation by tapping the Center Button, you have to terminate the intercom conversation manually. However, if you start the intercom by voice and end it manually by tapping the Center Button, you will not be able to start intercom by voice temporarily. In this case, you have to tap the Center Button to restart the intercom. This is to prevent repeated unintentional intercom connections by strong wind noise. After rebooting the headset, you can start the intercom by voice again.

10.2.6 VOX Sensitivity (Default: 3)

VOX sensitivity can be adjusted depending on your riding environment. Level 5 is the highest sensitivity setting and level 1 is the lowest.

10.2.7 Bluetooth® Intercom Audio Multitasking (Default: Disabled)

Audio Multitasking (Bluetooth® Intercom Audio Multitasking) allows you to have an intercom conversation while simultaneously listening to music, FM radio, or GPS instructions. The overlaid audio is played in the background with reduced volume whenever there is an intercom conversation and will return to normal volume once the conversation is finished.

Note:

- For Bluetooth® Intercom Audio Multitasking to work properly, you need to power the headset off and on. Please restart the headset.
- Bluetooth® Intercom Audio Multitasking will be activated during two-way intercom conversations with a headset that also supports this feature.
- Some GPS devices may not support this feature.
- The Audio Multitasking feature can be configured through the Intercom-Audio Overlay Sensitivity and the Audio Overlay Volume Management settings.

10.2.8 Intercom-Audio Overlay Sensitivity (Default: 3)

The music, FM radio and GPS volume will be lowered to play in the background if you talk over the intercom while the overlaid audio is playing. You can adjust the intercom sensitivity to activate this background audio mode. Level 1 has the lowest sensitivity and level 5 has the highest sensitivity.

Note: If your voice is not louder than the sensitivity of the selected level, the overlaid audio will not be lowered.

10.2.9 Audio Overlay Volume Management (Default: Disable)

The music, FM radio and GPS overlaid audio reduces in volume whenever there is an ongoing intercom conversation. If Audio Overlay Volume Management is enabled, the volume level of the overlaid audio will not be reduced during an intercom conversation.

10.2.10 HD Intercom (Default: Enable)

HD Intercom enhances the two-way intercom audio from normal quality to HD quality. HD Intercom will become temporarily disabled when you enter into a multi-way intercom. If this feature is disabled, the two-way intercom audio will change to normal quality.

Note:

- The intercom distance of HD Intercom is relatively shorter than normal intercom.
- HD Intercom will become disabled temporarily when Bluetooth® Intercom Audio Multitasking is enabled.

10.2.11 HD Voice (Default: Enable)

HD Voice allows you to communicate in high-definition during phone calls. This feature increases the quality so that the audio will be crisp and clear during phone call conversations.

Three-Way Conference Phone Call with Intercom Participant will not be available if HD Voice is enabled.

Note:

- Refer to the manufacturer of your Bluetooth® device that will be connected to the headset to see if it supports HD Voice.
- HD Voice is active only when Bluetooth® Intercom Audio Multitasking is disabled.

10.2.12 Smart Volume Control (Default: Disable)

Enabling Smart Volume Control automatically changes the level of the speakers volume based on the level of the environment noise. You can enable it by setting the sensitivity to low, medium or high.

10.2.13 Sidetone (Default: Disable)

Sidetone is audible feedback of your own voice. It helps you to naturally speak at the correct level according to varying helmet noise conditions. If this feature is enabled, you can hear what you are speaking during an intercom conversation or a phone call.

10.2.14 Voice Prompt (Default: Enable)

You can disable voice prompts by software configuration settings, but the following voice prompts are always on.

- Headset configuration settings menu, battery level indicator, speed dial, FM radio functions.

10.2.15 RDS AF Setting (Default: Disable)

Radio Data System (RDS) Alternative Frequency (AF) Setting allows a receiver to re-tune to the second frequency location when the first signal becomes too weak. With RDS AF enabled on the receiver, a radio station with more than one frequency can be used.

10.2.16 FM Station Guide (Default: Enable)

When FM Station Guide is enabled, FM station frequencies are given by voice prompts as you select preset stations. When FM Station Guide is disabled, the voice prompts on FM station frequencies will not be given as you select preset stations.

10.2.17 Advanced Noise Control™ (Default: Enable)

When Advanced Noise Control is enabled, the background noise is reduced during an intercom conversation. When it is disabled, the background noise is mixed with your voice during intercom.

11. TROUBLESHOOTING

Please visit www.interphone.com for video tutorials and answers to frequently asked questions.

11.1 Fault reset

When the intercom does not work properly, it is possible to reset the unit easily, simply by disconnecting the battery for few seconds.

Note: Reset after error will not restore the intercom to factory settings.

11.2 Factory reset

To erase all of your settings and start fresh, the headset can be restored to factory default settings using the Factory Reset feature.

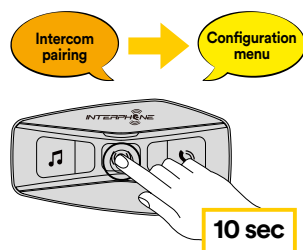

With U-COM 2 on, enter the configuration menu by pressing the power key for 10 seconds. Be careful not to release the button before the LED turns blue, you will hear the message confirming activation of the configuration menu.

Press the PHONE button twice until you hear the message “Factory reset”, press once the CENTRAL button to confirm. A voice announcement will be issued to confirm: “Reset headphones, goodbye”.